

# AUFBAUANLEITUNG

## Gerätehaus „NEO“ 1A, 2A, 1B und 2B

- Ⓜ GB Assembly manual for garden shed “NEO” size 1A, 2A, 1B and 2B
- Ⓜ FR Notice de montage pour l’abri de jardin “NEO” taille 1A, 2A, 1B et 2B
- Ⓜ NL Opbouwbeschrijving berging “NEO” grootte 1A, 2A, 1B en 2B
- Ⓜ ES Instrucciones de montaje de la caseta modelo “NEO” tamaño 1A, 2A, 1B y 2B
- Ⓜ IT Istruzioni di montaggio Casetta portattrezzi “NEO” misura 1A, 2A, 1B e 2B
- Ⓜ DK Monteringsvejledning for redskabsskuret “NEO” størrelse 1A, 2A, 1B og 2B

For additional languages please go to: [www.biohort.com/downloads](http://www.biohort.com/downloads)



QUALITÄT AUS  
ÖSTERREICH

# WICHTIGE PUNKTE FÜR DEN AUFBAU!



**VORLIEGENDE AUFBAUANLEITUNG ZEIGT DEN ZUSAMMENBAU VON „NEO“ GRÖSSE „2B“; SIE GILT SINNGEMÄSS AUCH FÜR DIE GRÖSSE „1A, 2A, 1B“. FÜR EINIGE MONTAGESCHRITTE BENÖTIGEN SIE 1 BIS 2 HELFER.**

- GB** Important details regarding assembly! This assembly manual shows the erection of the garden shed model "NEO" size "2B"; it is also valid for size "1A, 2A, 1B" For several assembly steps additional assistance of 1 or 2 people will be required.
- FR** Points importants lors du montage! " Cette notice de montage décrit l'assemblage de l'abri „NEO“ taille « 2B »; celle-ci est aussi valable pour la taille « 1A, 2A, 1B ». Pour certaines étapes, demandez l'aide d'une ou deux personnes.
- NL** Deze montage instructies hebben betrekking op de opbouw van de NEO , grootte 2B. De instructies zijn ook van toepassing op de grootte 1A, 2A, 1B. Voor enkele montage stappen heeft u 1 of 2 extra mensen nodig.
- ES** Notas importantes para el montaje: Estas instrucciones muestran el montaje de la caseta "NEO" en tamaño 2B. También son válidas para el tamaño 1A, 2A, 1B. Es recomendable realizar el montaje entre dos o tres personas.
- IT** Indicazioni importanti per il montaggio! Le seguenti istruzioni di montaggio fanno riferimento all'assemblaggio di „NEO“ misura „2B“; per analogia sono valide anche per la misura „1A, 2A, 1B“. Per alcune fasi di assemblaggio vi serviranno 1 - 2 aiutanti.
- DK** Vigtige punkter ved samling! Samlemanualen viser opsætningen af havekur modellen "NEO" str. "2B"; gælder også for størrelse "1A, 2A, 1B". Ved flere punkter af opsætningen er yderligere hjælp påkrævet af 1 eller 2 personer.

## BENÜTZEN SIE BEI DER MONTAGE ARBEITSHANDSCHUHE! UM KRATZER ZU VERMEIDEN, VERWENDEN SIE BITTE GEEIGNETE UNTERLAGEN!



- GB** Wear working gloves! Please use a suitable underlay to avoid scratches!
- FR** Portez des gants de travail! Pour éviter les rayures, utilisez les supports appropriés!
- NL** Handschoenen gebruiken! Om krassen te voorkomen raden wij u aan er iets onder te leggen!
- ES** Utilice unos guantes de trabajo. Por favor, coloque en el suelo una base protectora adecuada para evitar posibles arañazos.
- IT** Utilizzare guanti da lavoro. Utilizzare una base adatta per evitare graffi!
- DK** Brug arbejdshandsker! Benyt venligst et passende underlag for at undgå skrammer!

## SCHRAUBVERBINDUNGEN GRUNDSÄTZLICH ERST AM ENDE DER MONTAGE FESTZIEHEN!

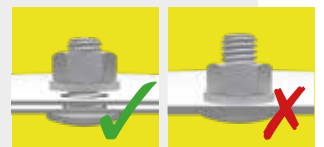

- GB** Nuts not to be tightened before the end of assembly!
- FR** Ne serrer les écrous à fond qu'à la fin du montage!
- NL** Schroeven pas aan het einde van de montage vastdraaien!
- ES** En principio, no apriete fijamente las tuercas hasta que no haya terminado de montar la caseta.
- IT** I dadi devono essere serrati a fondo soltanto alla fine del montaggio!
- DK** Møtrikkerne må ikke strammes før slutningen af opsætningen!

## ACHTEN SIE AUF EINE STURMSICHERE BODENVERANKERUNG UND VERSPERREN SIE DIE TÜREN! NICHT BEI WIND AUFBAUEN!



- GB** Please make sure the product is anchored in a storm-proof manner and lock the doors! Do not assembly in windy condition!
- FR** Veillez à ce que le sol soit ancré de manière à résister aux tempêtes et verrouillez les portes! Ne pas procéder au montage dans des conditions venteuses!
- NL** Zorg voor een stormbestendige bodem verankering en vergrendel de deuren! Niet opbouwen in winderige omstandigheden!
- ES** Asegúrese de que el suelo cuente con un anclaje a prueba de tormentas y cierre las puertas. ¡No se instalen en condiciones de viento!
- IT** Assicuratevi che il pavimento sia ancorato a prova di tempesta e chiudete a chiave le porte! Non montare in condizioni di vento!
- DK** Vær opmærksom på at produktet forankres stormsikkert samt at dør er aflåst! Bør ikke monteres ved kraftig vind!

## ACHTUNG: IM SOMMER KÖNNEN IM INNENRAUM SEHR HOHE TEMPERATUREN ENTSTEHEN!

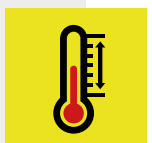

- GB** Attention: In the summer, the inside can reach very high temperatures!
- FR** Attention: En été la température à l'intérieur de l'abri peut être élevée!
- NL** Let op: in de zomer kunnen in de berging zeer hoge temperaturen bereikt worden.
- ES** Tenga en cuenta que en el verano las temperaturas en el interior pueden ser altas.
- IT** Attenzione: Si prega di prendere nota che in estate si possono essere temperature molto elevate all'interno.
- DK** Vigtigt: Der kan opstå meget høje temperaturer i skuret om sommeren.

## OPTIONALES ZUBEHÖR - SYMBOL:

Arbeits Schritte die blau eingerahmt sind, zeigen den Einbau eines optionalen Zubehörteiles.



- (GB)** Symbol of optional accessories: Blue framed assembly steps show the installation of optional accessories.
- (FR)** Accessoires en option-Symbole: La trame entourée en bleu indique une étape avec accessoires en option. A réaliser uniquement si vous avez commandé cet accessoire.
- (NL)** Extra Toebehoor: Montageschappen met een blauwe rand betreffen de inbouw van extra toebehoor.
- (ES)** Accesorio opcional – símbolo: Los pasos de montaje que se encuentran enmarcados en azul muestran el montaje de una pieza de un accesorio opcional.
- (IT)** Simbolo per accessori opzionali: Le fasi del montaggio incorniciate in colore azzurro mostrano l'installazione di un accessorio opzionale.
- (DK)** Symbol for ekstra udstyr: Blåt indrammet samlettrin viser installationen af ekstraudstyr

## MASSTABSGETREUE ABBILDUNGEN DER ZU VERWENDENDEN SCHRAUBEN:

- (GB)** Scale drawing 1:1 of the screws in use
- (FR)** Reproduction selon l'échelle 1:1.
- (NL)** Afbeelding : schaal 1:1 (ware grootte)
- (ES)** Reproducción a escala 1:1 de los tornillos que se utilizan para el montaje.
- (IT)** Immagine in scala delle viti da utilizzare!
- (DK)** Skala tegning af skruer er 1:1



## WASSERWAAGEN - SYMBOL: Betreffendes Einbauteil mit der Wasserwaage ausrichten.

- (GB)** Symbol of spirit level: Align the respective parts by using the spirit level.
- (FR)** Symbole niveau à bulle: Lorsque ce symbole apparaît, vous devez ajuster l'élément à l'aide d'un niveau à bulle.
- (NL)** Waterpas – symbol: Bij montageschappen waar dit symbool bijstaat is het noodzakelijk het betreffende onderdeel waterpas in te bouwen.
- (ES)** Símbolo del nivelador: Indica que se debe ajustar y centrar la pieza con la ayuda de un nivelador.
- (IT)** Simbolo di livella a bolla d'aria: Allineare il componente in questione con l'ausilio di una livella a bolla d'aria.
- (DK)** Symbol for vaterpas: Juster de respektive dele ved hjælp af vaterpas.

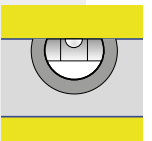

## QR-CODE: EINZELSCHRITTE ÜBER VIDEO ABRUFBAR

Bei bestimmten Montageschritten können Sie über den angegebenen QR-Code ein YouTube Video starten, welches Ihnen den dazugehörigen Montageschritt zeigt.

- (GB)** QR CODE: INDIVIDUAL STEPS CAN BE VIEWED VIA VIDEO. For certain assembly steps, you can start a YouTube video via the designated QR code, which shows you the corresponding assembly step.
- (FR)** QR-CODE : LES DIFFÉRENTES ÉTAPES PEUVENT ÊTRE VISUALISÉES PAR VIDÉO. Pour certaines étapes de montage, vous pouvez lancer une vidéo YouTube via le code QR spécifié, avec l'étape de montage correspondante.
- (NL)** QR-code: afzonderlijke stappen per video bekijken: Via de opgegeven QR-code kunt u voor bepaalde montageschappen een YouTube-video starten die u de bijbehorende montageschappen laat zien.
- (ES)** CÓDIGO QR: LOS PASOS INDIVIDUALES PUEDEN SER CONSULTADOS A TRAVÉS DE VIDEO. Para ciertos pasos de montaje, puedes iniciar un vídeo en YouTube mediante el código QR especificado, el cual muestra el paso de montaje correspondiente.
- (IT)** QR CODE: I SINGOLI PASSAGGI POSSONO ESSERE RICHIAMATI VIA VIDEO. Per determinate fasi di montaggio, è possibile avviare un video youtube tramite il codice qr specificato, che mostra la corrispondente fase di montaggio.
- (DK)** QR Kode: De enkelte skridt kan ses på video. For specifikke montage steps kan du se en YouTube video via den medfølgende QR kode, som viser de matchende montagevejledninger.



## EPDM-DACHFOLIE

Um die Lebensdauer der EPDM-Dachfolie zu verlängern, empfehlen wir die Beschwerung nach dem Aufbau mittels Terrassen-Gehwegplatten oder vergleichbare Beschwerungen (30x30x2/3/4 cm).

- (GB) EPDM roofing membrane: To extend the life of the EPDM roofing membrane, we recommend weighting it down after installation using concrete slabs or comparable weighting (30x30x2/3/4 cm).
- (FR) Feuille de toiture EPDM : Afin de prolonger la durée de vie de la feuille de toiture EPDM, nous recommandons de la lester après l'installation en utilisant des dalles de terrasse ou un lestage comparable (30x30x2/3/4 cm).
- (NL) EPDM-dakfolie: Om de levensduur van de EPDM-dakfolie te verlengen, raden wij aan deze na de installatie te verzwaren met beton tegels of een vergelijkbare verzwarening (30x30x2/3/4 cm).
- (ES) Lámina de tejado EPDM: Para prolongar la vida útil de la lámina de tejado EPDM, se recomienda lastrarla después de su instalación con losas o similares (30x30x2/3/4 cm).
- (IT) Telo per tetto EPDM: Per prolungare la durata del telo per tetto EPDM, si consiglia di appesantirlo dopo l'installazione con mattonelle(marmettoni) per pavimenti o pesi simili (30x30x2/3/4 cm).
- (DK) EPDM-Folie: For at forlænge EPDM-foliens levetid, anbefaler vi at tyngde med terrassefliser eller lignende belastning (30x30x2/3/4cm).



Für alle weiteren Größen finden Sie Details in den FAQ unter [www.biohort.com/epdm-dachfolie](http://www.biohort.com/epdm-dachfolie)  
For all other sizes you can find details in the FAQ section via [www.biohort.com/epdm-dachfolie](http://www.biohort.com/epdm-dachfolie).  
Vous trouverez plus de détails sur les autres tailles dans les FAQ à ce lien : [www.biohort.com/epdm-dachfolie](http://www.biohort.com/epdm-dachfolie)  
Voor alle andere maten, zie de FAQ op [www.biohort.com/epdm-dachfolie](http://www.biohort.com/epdm-dachfolie) voor details.  
Para todos los otros tamaños, consulte las preguntas más frecuentes en [www.biohort.com/epdm-dachfolie](http://www.biohort.com/epdm-dachfolie) para más detalles.  
Per tutte le altre dimensioni, potete trovare i dettagli nelle FAQ sotto [www.biohort.com/epdm-dachfolie](http://www.biohort.com/epdm-dachfolie)  
For alle andre størrelser kan du finde oplysninger i FAQ på [www.biohort.com/epdm-dachfolie](http://www.biohort.com/epdm-dachfolie)

**HALTEN SIE WÄHREND DES ZUSAMMENBAUS ALLE MITGELIEFERTEN KLEINTEILE ODER VERPACKUNGSMATERIALIEN VON KLEINKINDERN FERN. Bauteile weisen scharfe Kanten auf oder stehen vor, achten Sie während der Montage und bei der täglichen Nutzung darauf.**

- (GB) Keep all supplied small parts or packaging materials away from little children during assembly. Components have sharp edges or protrude, pay attention to them during assembly and during daily use.
- (FR) Gardez toutes les petites pièces ou les matériaux d'emballage fournis hors de portée des enfants pendant le montage. Les pièces d'assemblage peuvent être tranchantes, faites-y attention lors de l'assemblage et de l'utilisation quotidienne.
- (NL) Houd alle kleine onderdelen of verpakkingsmaterialen die worden mee geleverd uit de buurt van kleine kinderen tijdens de montage. Onderdelen hebben scherpe randen of steken uit, let op bij de montage en bij het dagelijks gebruik.
- (ES) Mantenga todas las piezas pequeñas o materiales de embalaje suministrados lejos de los niños durante el montaje. Los componentes tienen bordes afilados o salientes, preste atención a ellos durante el montaje y durante el uso diario.
- (IT) Tenere tutte le piccole parti o i materiali d'imballaggio forniti lontano dalla portata dei bambini durante il montaggio. I componenti hanno spigoli vivi o sporgenti, prestare attenzione ad essi durante il montaggio e durante l'uso quotidiano.
- (DK) Hold alle leverede smådele og emballage utilgængeligt for børn under montagen. Komponenter har skarpe kanter eller stikker ud, vær opmærksom på dem under montering og under daglig brug.



## UMGANG MIT BESCHÄDIGTEN TEILEN

**Verbauen Sie keine beschädigten Teile! Falls Sie Beschädigungen feststellen, müssen diese vorab inkl. aussagekräftiger Bilder an uns gemeldet werden. Durch den Verbau gelten die Teile als akzeptiert.**

- (GB)** Handling of damaged parts: Do not install damaged parts! If you note damages, they must be reported to us in advance, including meaningful pictures. The parts are considered accepted by the installation.
- (FR)** Manipulation des pièces endommagées: N'installez pas de pièces endommagées ! Si vous découvrez des dommages, vous devez nous en informer à l'avance, en nous envoyant des photos significatives. Après le montage, les pièces sont considérées comme acceptées.
- (NL)** Omgaan met beschadigde onderdelen: Monteer géén beschadigde onderdelen! Als u schade ontdekt, moet dit vooraf aan ons worden gemeld, inclusief duidelijke foto's. Als u de beschadigde onderdelen toch monteert, dan heeft u hiermee het product "geaccepteerd".
- (ES)** Manejo de partes dañadas: Por favor, NO instale partes dañadas, Si descubre algún daño, debe informarnos con antelación, incluyendo fotos claras de los daños. Las piezas se consideran aceptadas si se realiza su la instalación.
- (IT)** Gestione di parti danneggiate: Non installare parti danneggiate! Se si rivela un danno, questo deve essere segnalato in anticipo per mail con materiale fotografico a supporto del reclamo. Se si procede all'installazione delle parti danneggiate, Biohort si riserva il diritto di respingere il reclamo.
- (DK)** Håndtering af beskadigede dele: Brug ikke beskadigede dele! Hvis du opdager nogen skade, skal dette rapporteres til os på forhånd, herunder meningsfulde billeder. Dele betragtes som accepteret gennem installationen.

## PFLEGE UND WARTUNG

- **Keine aggressiven Chemikalien wie z.B. Chlor oder Streusalz lagern!**
- **Sonnenmilch und andere Cremes mit Wasser und Seife entfernen.**
- **Keine scheuernden Reinigungsmittel verwenden!**
- **Laub vom Dach regelmäßig entfernen! Dachgully kontrollieren!**
- **Tiefe Kratzer sofort mit beiliegendem Lack ausbessern!**
- **Ölen Sie das Schloss jährlich!**
- **Schraubverbindungen regelmäßig kontrollieren!**

- (GB)** Care and maintenance: Do not store aggressive substances i.e. chlorine or road salt! Remove suntan lotion or any other creams with soap and water! Do not use abrasive cleaning agents! Keep the roof free of leaves! Check roof gully! Touch-up scratches immediately with the paint provided. Lubricate the lock once a year! Check screw connections regularly!
- (FR)** Entretien et maintenance: Ne pas stocker de produits chimiques (chlore, sel, etc...)! Nettoyez uniquement avec de l'eau les crèmes solaires et autres crèmes (pas de nettoyant chimique). Ne pas utiliser de produits nettoyant abrasifs! Débarrassez vous régulièrement des feuilles mortes sur le toit! Vérifiez la gouttière du toit ! Corrigez immédiatement les rayures avec la laque jointe! Graissez la serrure et les charnières chaque année! Vérifiez régulièrement les raccords à vis!
- (NL)** Onderhoud: Geen chemicaliën in de berging opslaan! Zonnebrandolie/melk en andere cremes met water en glansmiddel verwijderen. Gebruik geen schuurmiddelen! Regelmatig bladeren van dak verwijderen! Controleer de dakgoot! - Krassen direct met de meegeleverde lak behandelen. Slot jaarlijks oliën. Controleer regelmatig de schroefverbindingen!
- (ES)** Cuidado y mantenimiento: No almacene productos químicos agresivos dentro de la caseta como por ejemplo cloro y sal antiescarcha. Evite dejar huellas o restos de cremas solares sobre la chapa. Limpie la caseta siempre con agua y jabón. No utilice ningún producto para fregar. En general, evite siempre cualquier producto químico para limpiar la caseta. Mantenga el tejado libre de hojas secas. Compruebe el desagüe del tejado . Repare los arañazos lo antes posible con el barniz que se incluye. Aplique aceite en la cerradura y las bisagras una vez al año. ¡Compruebe las conexiones de los tornillos regularmente!
- (IT)** Manutenzione: Non lasciare prodotti chimici aggressivi (come ad esempio cloro o sale per strade) all'interno della casetta! Rimuovere crema solare e altre creme con acqua e brillantante! Non utilizzare detergenti contenenti sostanze aggressive! Mantenere il tetto libero da foglie! Controllare la grondaia! Ritoccare immediatamente eventuali graffi con la vernice fornita nella confezione! Lubrificare la serratura e le cerniere a cadenza annuale! Controllare regolarmente i collegamenti a vite!
- (DK)** Pleje og vedligeholdelse: Opbevar ikke aggressive stoffer dvs. Klor eller vejsalt! Fjern solcreme eller andre typer af creme med vand og rensningsmiddel! Brug ikke aggressive rengøringsmidler! Hold taget fri for blade! Kontroller tagafløb! Ved skrammer, brug straks malingen som er stillet til rådighed! Smør låsen årligt! Kontroller skruesamlinger jævnligt!

## ZUM SORTIEREN DER MITGELIEFERTEN SCHRAUBEN UND KLEINTEILE FINDEN SIE IM KARTON EIN FALTBARES ORDNUNGSSYSTEM.



- (GB)** For sorting the supplied screws and small parts, you will find a foldable organiser system in the box.
- (FR)** Pour trier les vis et les petites pièces fournies, vous trouverez dans le colis un système d'organisation pliable.
- (NL)** Om de meegeleverde schroeven en kleine onderdelen te sorteren, vindt u in de doos een opvouwbaar opbergstelsysteem.
- (ES)** Para clasificar los tornillos y las piezas pequeñas suministradas, encontrará en la caja un sistema organizador plegable.
- (IT)** Per sistemare le viti e le piccole parti in dotazione, troverete un contenitore pieghevole nella scatola.
- (DK)** For at sortere de medfølgende skruer og små dele, finder du et foldbart organisationssystem i kassen.



## VORSCHLÄGE FÜR DAS FUNDAMENT

Bitte achten Sie bei der Fundamentgestaltung darauf, dass Niederschlagswasser nicht seitlich unter den Bodenprofilen in das Gerätehaus eindringen kann! Aufsteigende Bodenfeuchtigkeit und Kondensation vermeiden Sie mittels einer starken Kunststoffolie unter dem Fundament.

- (GB)** Proposals for a secure foundation: When making the foundation arrangements please take necessary precaution to ensure that water cannot leak in under the floor profiles. Rising ground moisture and condensation can be avoided by using a strong plastic sheet underneath the paving slabs or underneath the concrete foundation.
- (FR)** Conseils pour les fondations: Lors de la réalisation de la fondation, veillez à ce que l'eau de pluie ne puisse pas pénétrer dans l'abri ou par les côtés sous les profils de sol. Vous pouvez éviter l'humidité du sol et la condensation en mettant un film plastique épais sous les plaques de béton.
- (NL)** Voorstellen voor fundament : Let er bij het maken van de fundering op dat regenwater niet onder het bodemprofiel kan doorlopen. Een vochtige bodem en condensatie kunt u vermijden door het aanbrengen van een sterke kunststoffolie onder de tegels of het betonfundament.
- (ES)** Medidas y recomendaciones para los cimientos: Al colocar los cimientos, asegúrese de que el agua de lluvia no puede penetrar en la caseta por los laterales debajo del perfil del suelo. Evite la humedad y la condensación en el suelo colocando una lámina de plástico bajo las losas o los cimientos de hormigón.
- (IT)** Proposte per il basamento: Il basamento deve essere progettato in modo da evitare infiltrazioni di acqua piovana all'interno della casetta. Un telo di plastica spesso posto in corrispondenza dell'area di pavimento evita infiltrazioni di umidità dal terreno e la formazione di condensa.
- (DK)** Forslag til sikkert fundament: Ved etablering af fundament skal du tage de nødvendige forholdsregler for at sikre, at vand ikke kan sive ind under gulvprofilerne. Stigende fugt og kondens i jorden kan undgås ved at bruge plastik under flisebelægningen eller under betonfundamentet:



Weitere Details betreffend Fundament finden Sie auch unter [www.biohort.com/Fundament](http://www.biohort.com/Fundament)  
Further details about foundations you will find at [www.biohort.com/foundation](http://www.biohort.com/foundation)  
Pour des détails supplémentaires, veuillez consulter [www.biohort.com/foundations](http://www.biohort.com/foundations)  
Verdere details over het fundament vindt u ook op [www.biohort.com/fundament](http://www.biohort.com/fundament)  
Encuentre información detallada sobre los cimientos en: [www.biohort.com > servicios > cimientos](http://www.biohort.com > servicios > cimientos)  
Per ulteriori dettagli si prega di consultare [www.biohort.com/it/servizi/suggerimenti-per-le-fondamenta](http://www.biohort.com/it/servizi/suggerimenti-per-le-fondamenta)  
Yderligere informationer om fundamentet finder du på [www.biohort.com/foundation](http://www.biohort.com/foundation)

## MASSE FÜR DAS FUNDAMENT

- (GB)** Foundation dimensions
- (FR)** Dimensions pour la fondation
- (NL)** Maat voor het fundament
- (ES)** Medidas de los cimientos
- (IT)** Dimensioni del basamento
- (DK)** Fundament dimensioner

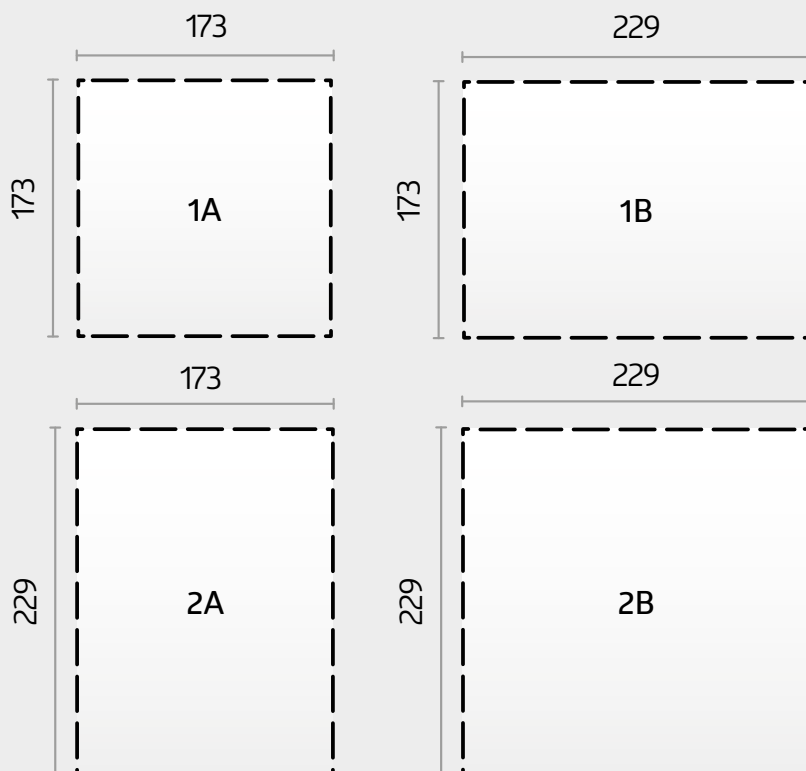

## FÜR DIE MONTAGE WERDEN MINDESTENS 70 CM PLATZ RUND UM DAS FUNDAMENT BENÖTIGT!

- (GB)** At least 70 cm space around the foundation is required for installation.
- (FR)** Un espace d'au moins 70 cm autour de la fondation est nécessaire pour le montage.
- (NL)** Voor de montage is ten minste 70 cm ruimte rond de fundering nodig.
- (ES)** Se requiere un espacio de al menos 70 cm alrededor de los cimientos para su instalación.
- (IT)** Per l'installazione sono necessari almeno 70 cm di spazio intorno alla fondazione.
- (DK)** For montage kræves yderligere 70cm plads omkring fundamentet



## SMARTBASE



## SMARTBASE<sup>PLUS</sup>



## BETONFUNDAMENT - CONCRETE FOUNDATION - FONDATION EN BÉTON

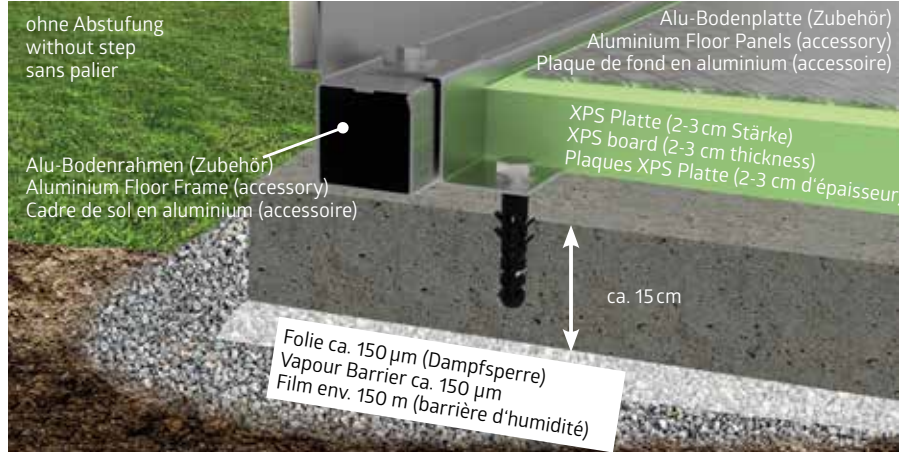

## PUNKTFUNDAMENT POINT FOUNDATION - FONDATION PAR POINT



## BODENRAHMEN FLOOR FRAME - CADRE DE SOL

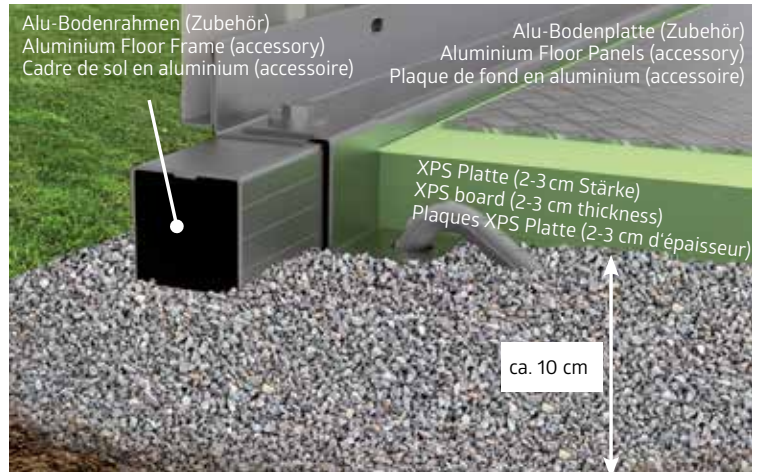

## GEHWEGPLATTEN PAVING SLABS - DALLES EN BÉTON

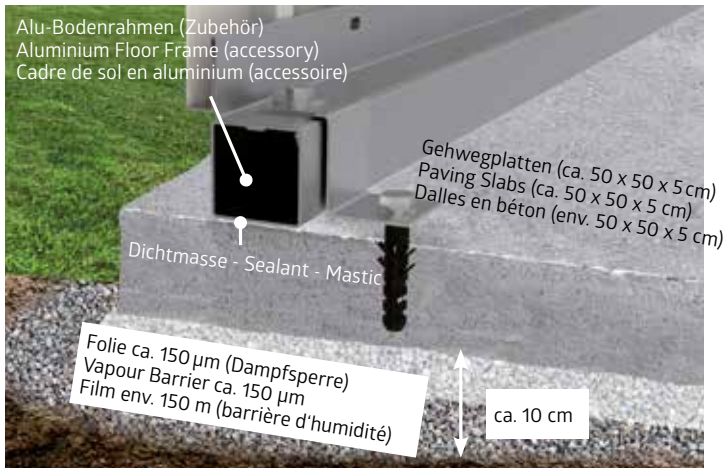

## FUNDAMENTLÖSUNGEN

- |  |                                |
|--|--------------------------------|
| <b>GB</b> Foundation solutions         | <b>SI</b> Temeljne rešitve     |
| <b>FR</b> Solutions de fondations      | <b>CZ</b> Řešení nadace        |
| <b>NL</b> Fundamentsoplossingen        | <b>HU</b> Alapozási megoldások |
| <b>ES</b> Soluciones de fundamentación | <b>HR</b> Temeljna rješenja    |
| <b>IT</b> Soluzioni per la fondazione  |                                |
| <b>DK</b> Fundamentløsninger           |                                |
| <b>SE</b> Grundlösningar               |                                |
| <b>NO</b> Fundamentløsninger           |                                |
| <b>PL</b> Rozwiązania fundamentowe     |                                |
| <b>SK</b> Nadačné riešenia             |                                |

biohort.com/  
fundament



## EINBAUMÖGLICHKEITEN DER TÜREN ANSTELLE VON WANDELEMENTEN!

- (GB)** The door can be installed instead of side wall elements!
- (FR)** La porte peut être installée sur le côté à la place d'une paroi latérale !
- (NL)** Inbouwmogelijkheden van de deuren i.p.v. de wandelementen
- (ES)** Es posible colocar las puertas en lugar de los paneles laterales.
- (IT)** Considerare la possibilità di montare una porta standard al posto di una parete laterale!
- (DK)** Døren kan monteres i stedet for et sidevæg element!

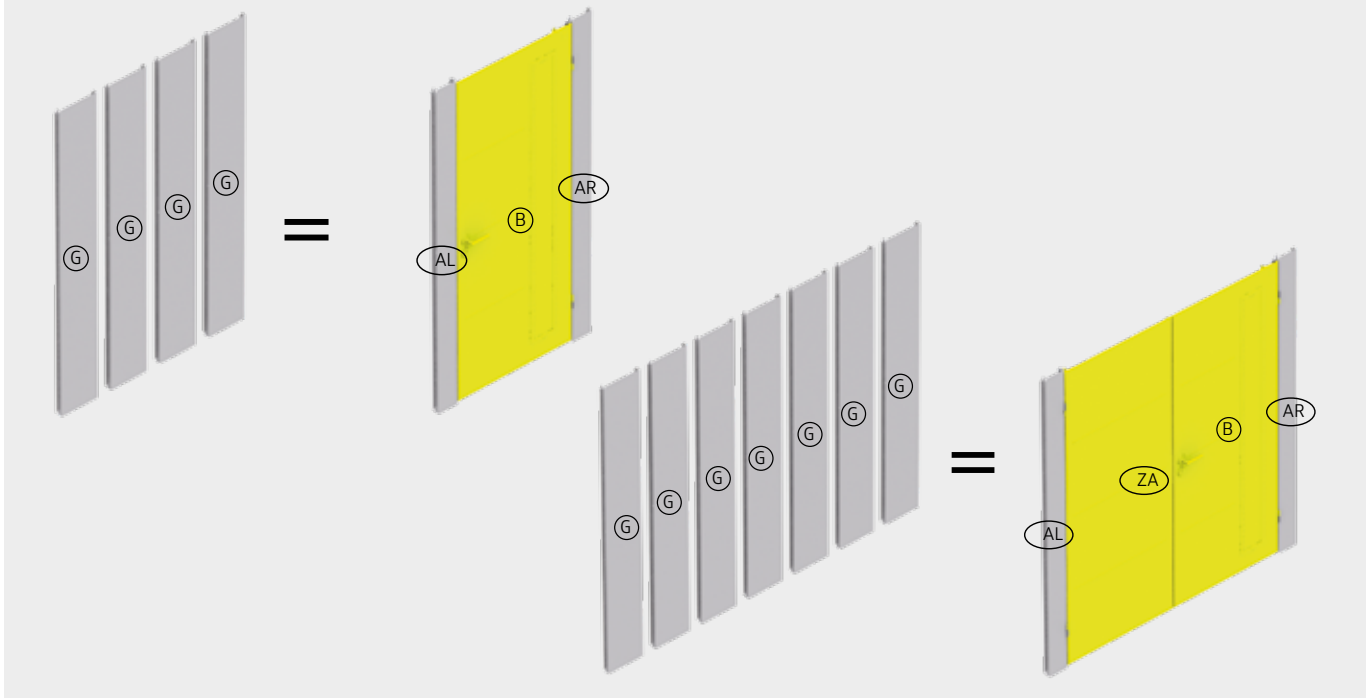

## PANEELE MIT PFEILRICHTUNG NACH UNTEN VERBAUEN!

- (GB)** Install the panels with the arrows pointing downwards!
- (FR)** Installez les panneaux en suivant le sens des flèches vers le bas!
- (NL)** Installeer de panelen met de richting van de pijl naar beneden!
- (ES)** ¡Instale los paneles con la dirección de las flechas apuntando hacia abajo!
- (IT)** Installare i pannelli con la direzione delle frecce rivolte verso il basso!
- (DK)** Installer paneler med pilen pegende nedad!

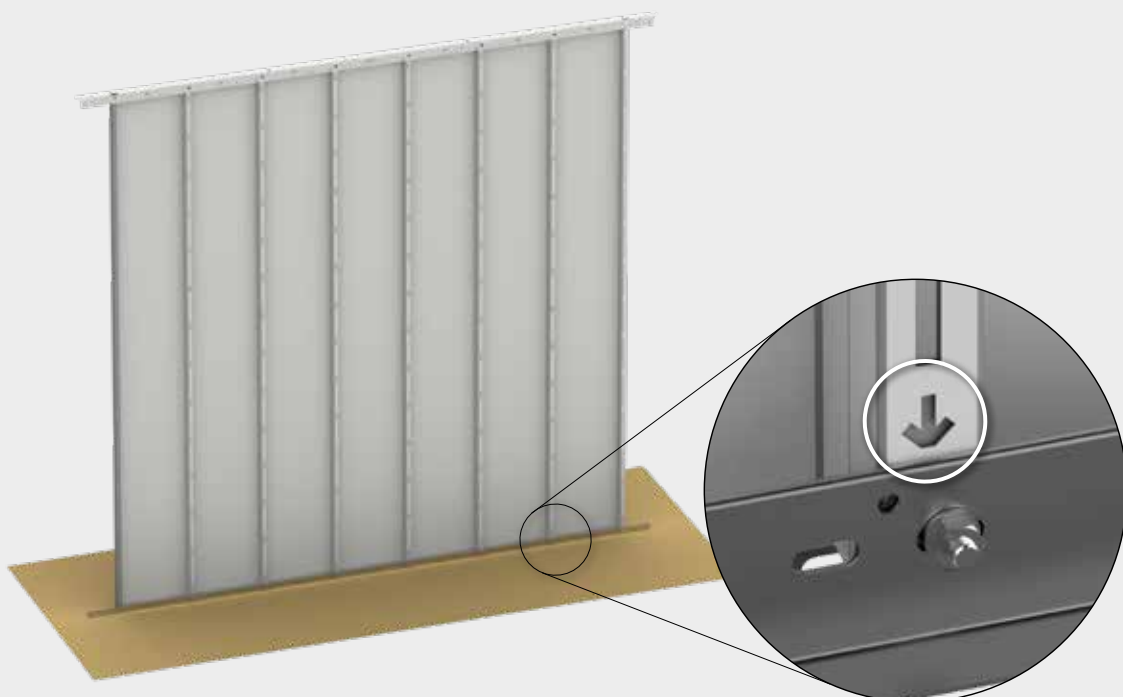
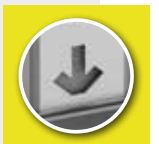

## EINBAUMÖGLICHKEITEN DES LICHTPANEELS ANSTELLE VON WANDELEMENTEN

Installation options of the glass panel instead of wall elements - Possibilités d'installation du panneau lumineux à la place des éléments muraux - Montage mogelijkheden van het lichtpaneel ter vervanging van de wandelementen - Posibilidad de instalación del panel de luz en lugar de los elementos de pared - Possibilità di installazione del pannello luminoso al posto degli elementi a parete - Installationsmuligheder for lyspanelet i stedet for vægelementer

### MONTIEREN SIE LINKS UND RECHTS NEBEN DEM LICHELEMENT IMMER EIN WANDELEMENT!

- (GB)** Always install a wall element to the left and right of the glass panel!
- (FR)** Installez toujours un élément mural à gauche et à droite du panneau lumineux !
- (NL)** Plaats altijd een wandelement links en rechts van het lichtelement!
- (ES)** ¡Siempre debe instalarse un elemento de pared a la izquierda y a la derecha del elemento de iluminación!
- (IT)** Installare sempre un elemento a parete a sinistra e a destra dell'elemento di illuminazione!
- (DK)** Monter altid et vægelement til venstre og højre for lyselementet!

### MONTIEREN SIE DAS LICHTPANEEL NICHT DIREKT NACH EINEM ECKELEMENT UND NICHT DIREKT NEBENEINANDER!

- (GB)** Do not install the glass panel directly after a corner element or directly next to one another!
- (FR)** Ne montez pas le panneau lumineux directement après un élément d'angle et non plus directement l'un à côté de l'autre !
- (NL)** Monteer een lichtpaneel niet direct na een hoekelement en niet direct naast elkaar!
- (ES)** ¡No monte el panel de luz directamente después de un elemento de esquina y no directamente uno al lado del otro!
- (IT)** Non montate il pannello luminoso direttamente dopo un elemento angolare o uno accanto all'altro!
- (DK)** Monter ikke lyspanelet direkte efter et hjørneelement og ikke direkte ved siden af hinanden!

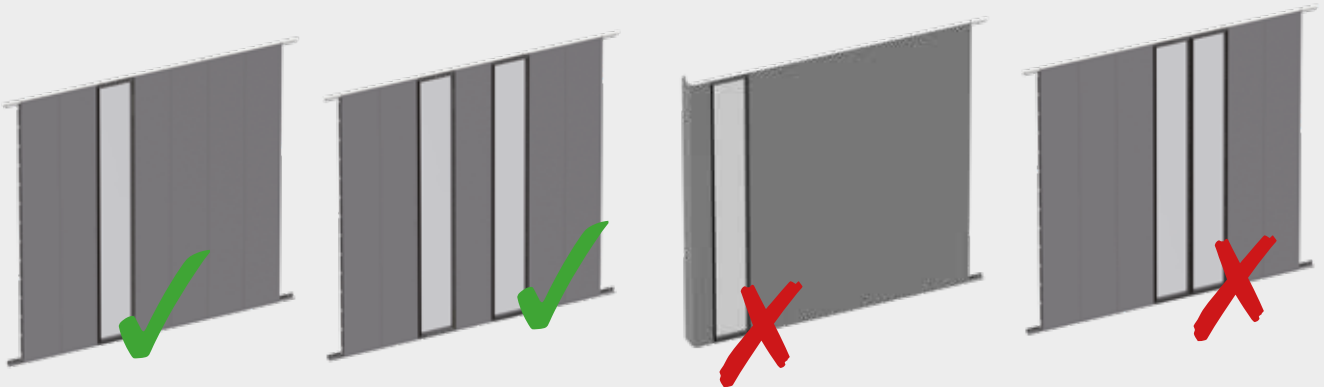

## PFLEGE GLASELEMENTE!

Glaselemente mit weichem Schwamm und mildem Reiniger säubern und mit klarem Wasser abspülen. Anschließend mit einem weichem, fusselfreiem Tuch trocknen. Weitere Hinweise finden Sie unter [www.biohort.com](http://www.biohort.com)

- (GB)** Care of Glass Elements! Clean glass elements with a soft sponge and mild cleaner and rinse with clear water. Then dry with a soft, lint-free cloth. You will find further information at [www.biohort.com](http://www.biohort.com).
- (FR)** Entretien des éléments en verre! Nettoyez les éléments en verre avec une éponge douce et un nettoyant doux, puis rincez à l'eau claire. Séchez ensuite avec un chiffon doux et non pelucheux. Vous trouverez de plus amples informations sur le site [www.biohort.com](http://www.biohort.com).
- (NL)** Verzorging van glaselementen! Reinig glazen elementen met een zachte spons en een mild schoonmaakmiddel en spoel af met helder water. Vervolgens afdrogen met een zachte, pluivrije doek. Meer informatie is te vinden op [www.biohort.com](http://www.biohort.com)
- (ES)** Cuidado de los elementos de vidrio! Limpie los elementos de vidrio con una esponja y un detergente suaves y enjuague con agua limpia. A continuación, secar con un paño suave y sin pelusas. Puede encontrar más información en [www.biohort.com](http://www.biohort.com)
- (IT)** Cura degli elementi in vetro! Pulire gli elementi in vetro con una spugna morbida e un detergente delicato e risciacquare con acqua pulita. Poi asciugare con un panno morbido e senza pelucchi. Potete trovare ulteriori informazioni su [www.biohort.com](http://www.biohort.com)
- (DK)** Vedligehold af glaselementer! Glaselementerne rengøres med en blød svamp og mildt rengøringsmiddel. Skyl efterfølgende med rent vand. Elementerne tørres med en blød fnugfri klud. Yderligere information kan findes på [www.biohort.com](http://www.biohort.com)







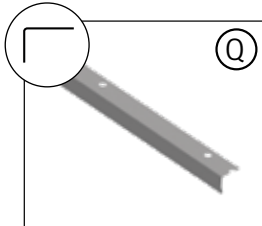
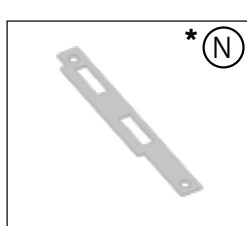
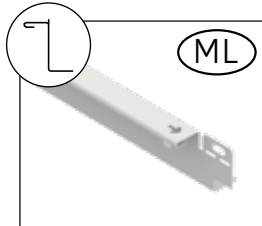
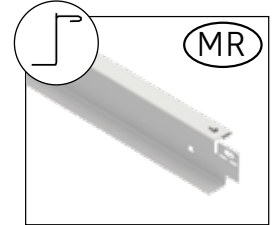
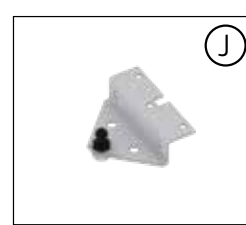
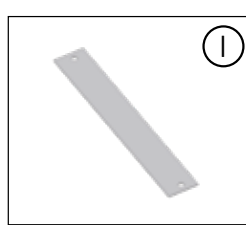
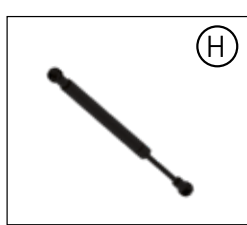
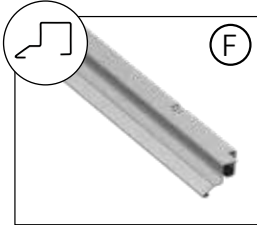
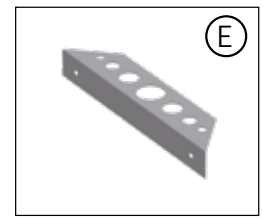
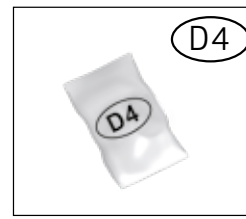
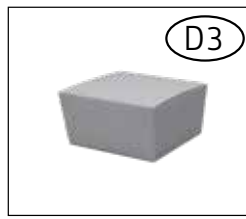
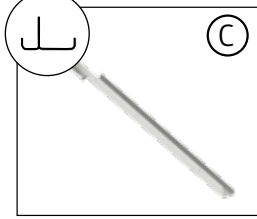
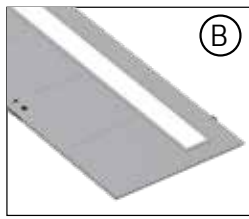

## 1 STANDARDTÜR - PAKET

Standard door package · Carton de portes standard · Standaard deurpakket · Puertas estándar · Pacco porta standard · Standarddørpakke



**ZUSATZTEILE DOPPELTÜR**  
 double door package | carton de double portes |  
 dubbeldeurpakket | pacco porta doppia |  
 kit de puerta adicional | Ekstradele dobbeltdør

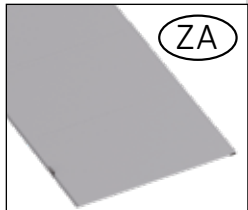
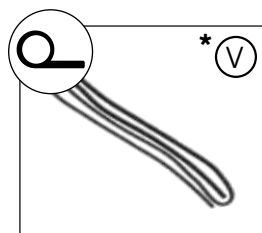



### \* TEIL ENTFÄLLT BEI DER DOPPELTÜR

- (GB) Part not required when double doors are fitted
- (FR) La pièce est supprimée pour la double portes.
- (NL) Deel vervalt bij de dubbele deur
- (ES) Pieza no es necesaria en caso de puerta doble
- (IT) Pezzo non può essere utilizzato per la variante porta a due battenti
- (DK) Del ikke nødvendig med dobbeltdør

## 2 SEITENWAND - PANEELPAKET

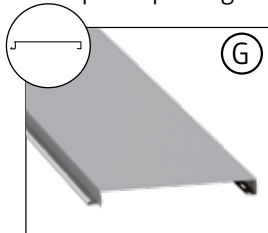
Side panel package · Carton de parois latérales · Zijwandpakket · Panel la teral · Pacco pareti laterali · Sidepladepakke



## 3 PROFIL - PAKET

Profile package · Carton de profils · Profielpakket · Kit de perfiles · Pacco profili · Profilpakke

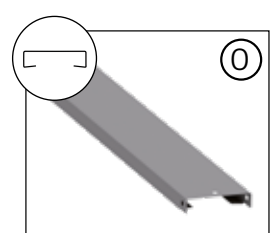
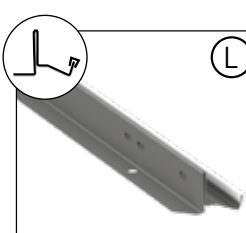
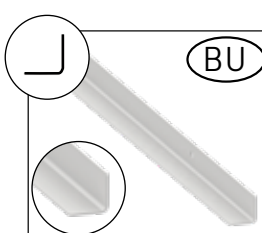
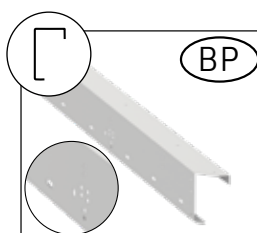
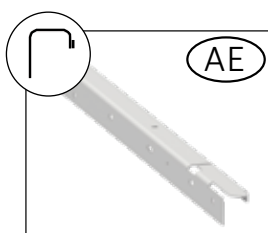

## 3a PROFIL - PAKET

Profile package · Carton de profils · Profielpakket · Kit de perfiles · Pacco profili · Profilpakke

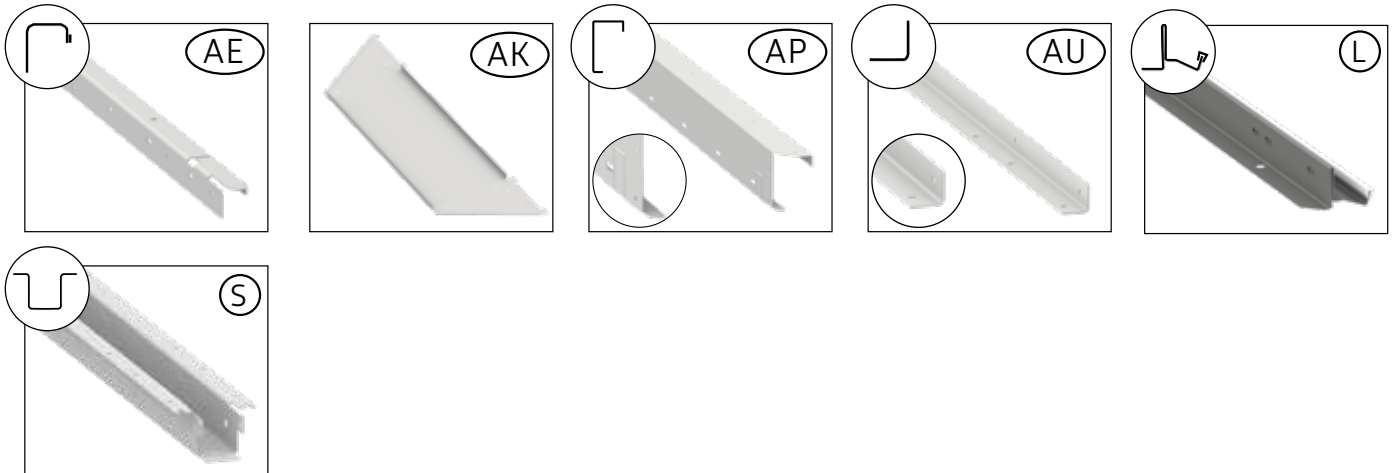

## 4 DACH - HOLZPAKET

Wood roof package · Colis du toit en bois · Houten dakbedekking pakket · Paquete para el techo · Madera · Pacchetto di legno per tetti · Tagpakke træ



## 5 DACH - PROFILPAKET

Roof profil package · Carton de profils de toit · Dakprofielpakket · Kit de perfiles de tejado · Pacco profili del tetto · Tagprofilpakke

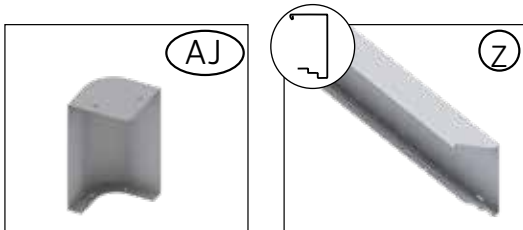

## 6 DACH - FOLIENPAKET

Roofing membrane package · Colis du film EPDM du toit · Dakfolie pakket · Paquete-Película para el techo · Pacchetto di telo per tetto · Tagpakke folie





## ECKPANEEL - PAKET

Corner panel package · Colis des parois d'angle · Hoekpaneel pakket · Paquete de paneles de esquina · Pacchetto pannello angolare · Hjørnepanel pakke

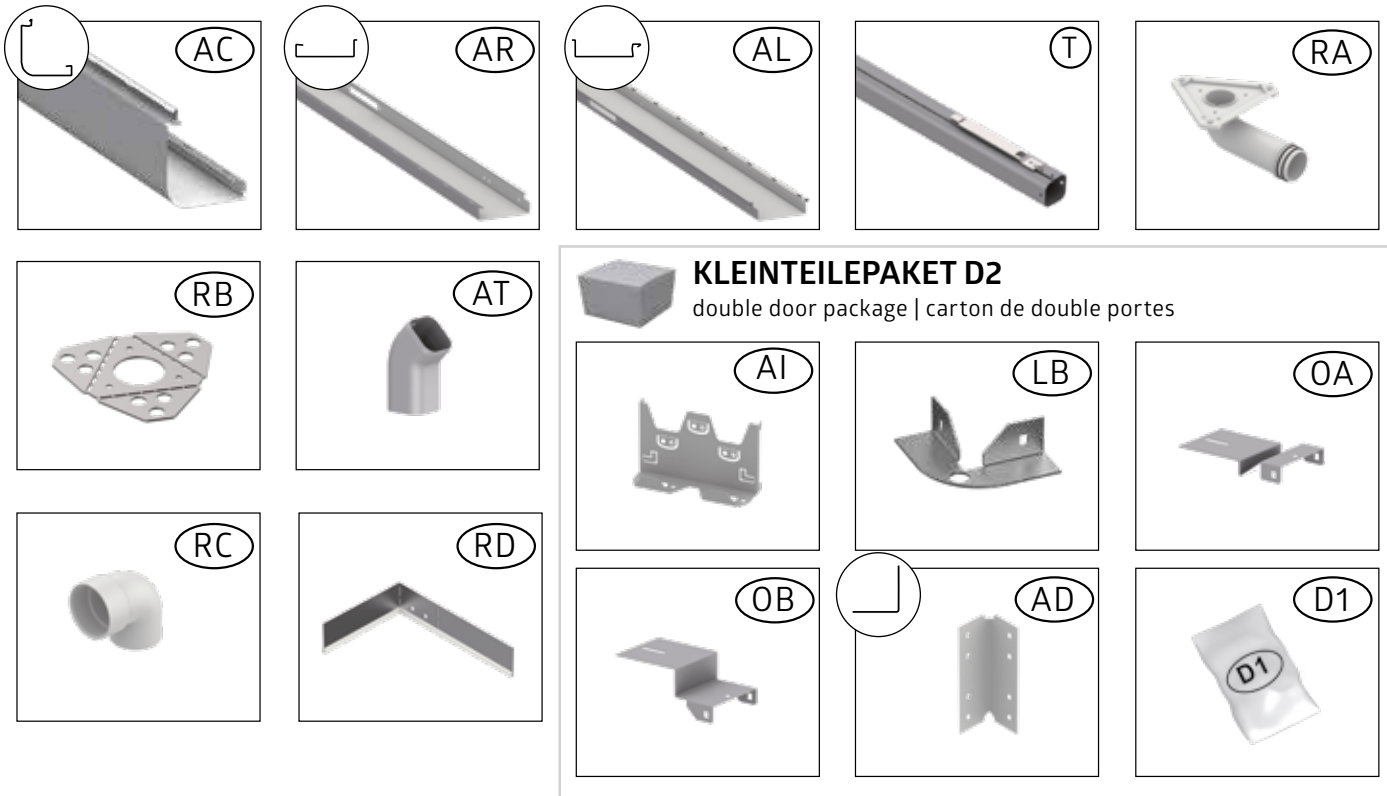

## BODENRAHMEN - OPTIONAL

Floor frame · Cadre de sol · Bodemframe · Marco de suelo · Telaio perimetrale · Bundramme

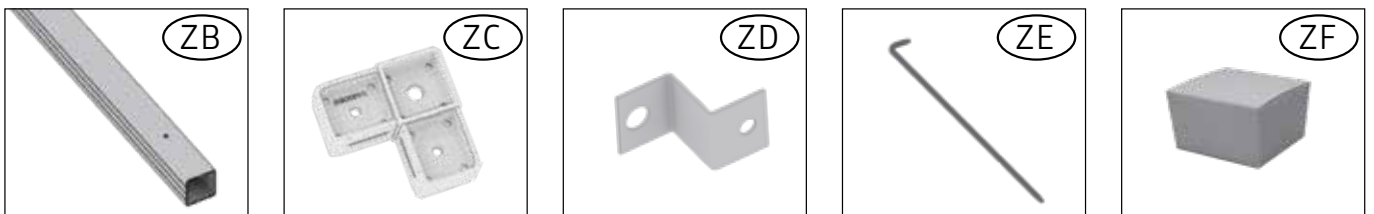

## LICHTPANEEL - OPTIONAL

Acrylic glass panel · Panneau lumineux · Lichtpaneel · Panel de luz · Elemento in vetro acrilico · Akrylglas panel

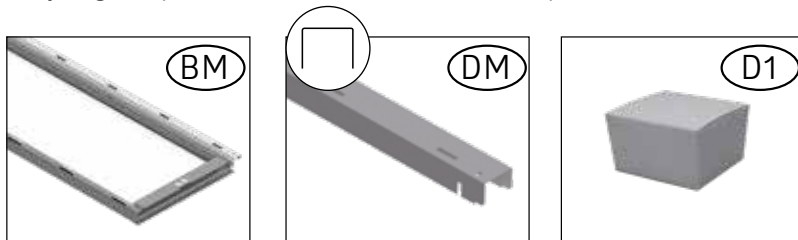







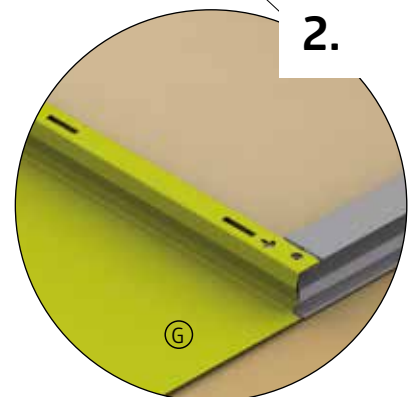
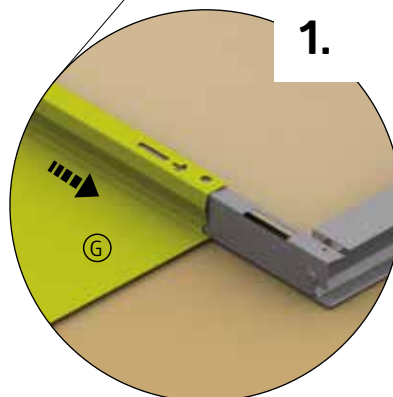
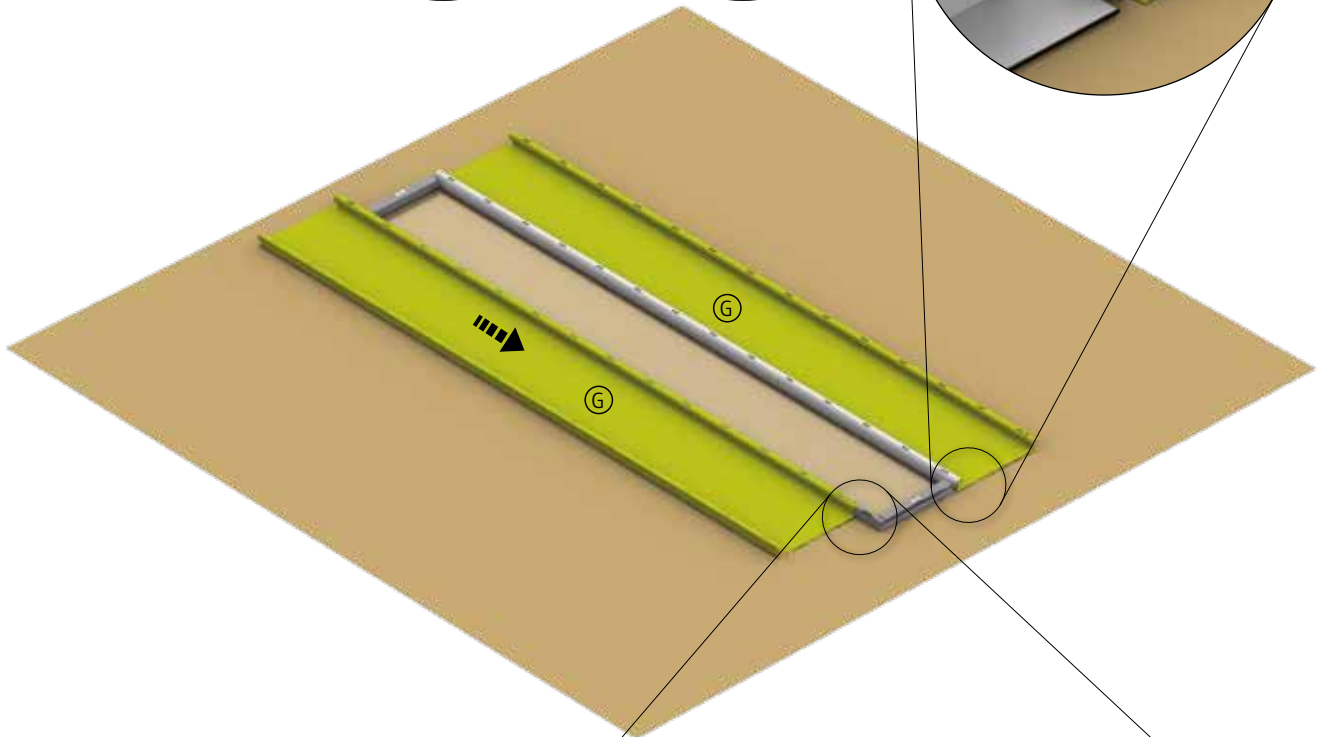
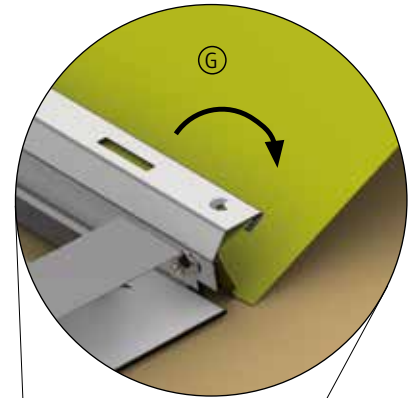
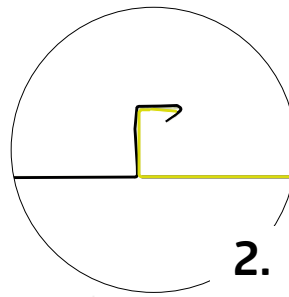
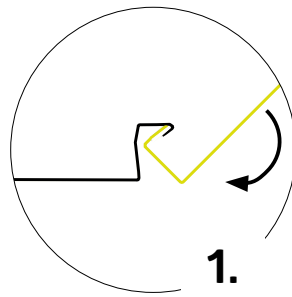

# Lichtpaneel

Acrylic glass panel · Panneau lumineux · Lichtpaneel · Panel de luz · Elemento in vetro acrilico · Akrylglas panel















	1A: 2x		1A: 1x
	2A: 2x		2A: 1x
	1B: 2x		1B: 1x
	2B: 2x		2B: 1x



M5 x 10 		1A: 2x
		2A: 2x
		1B: 2x
		2B: 2x



### Festziehen

-  Tighen
-  Serrez fort
-  Vastdraaien
-  Apriete
-  Serrare a fondo
-  Fastspænding
-  Draät
-  Stramme
-  Dokręćć
-  Dotiahnuť
-  Zategnite
-  Dotáhnout
-  Erősen meghúzni
-  Zategnite

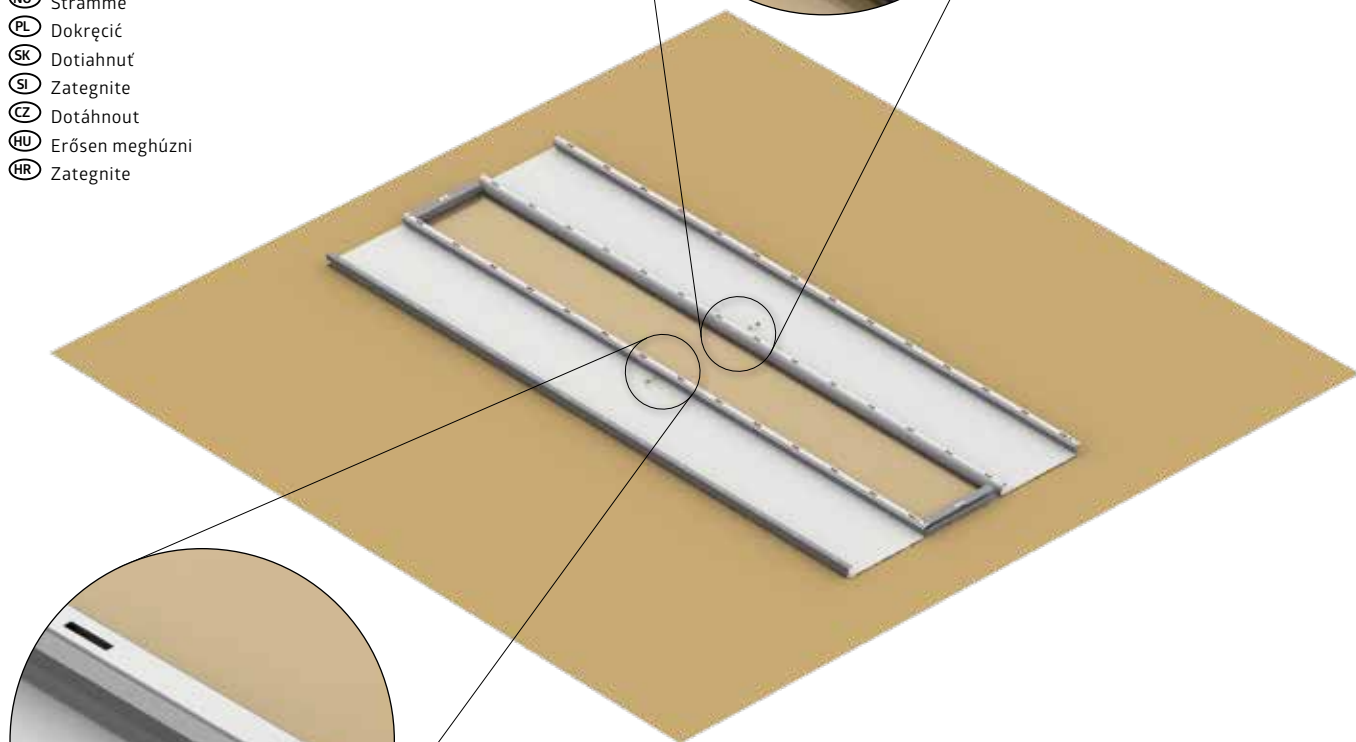



# Lichtpaneel

Acrylic glass panel · Panneau lumineux · Lichtpaneel · Panel de luz · Elemento in vetro acrilico · Akrylglas panel

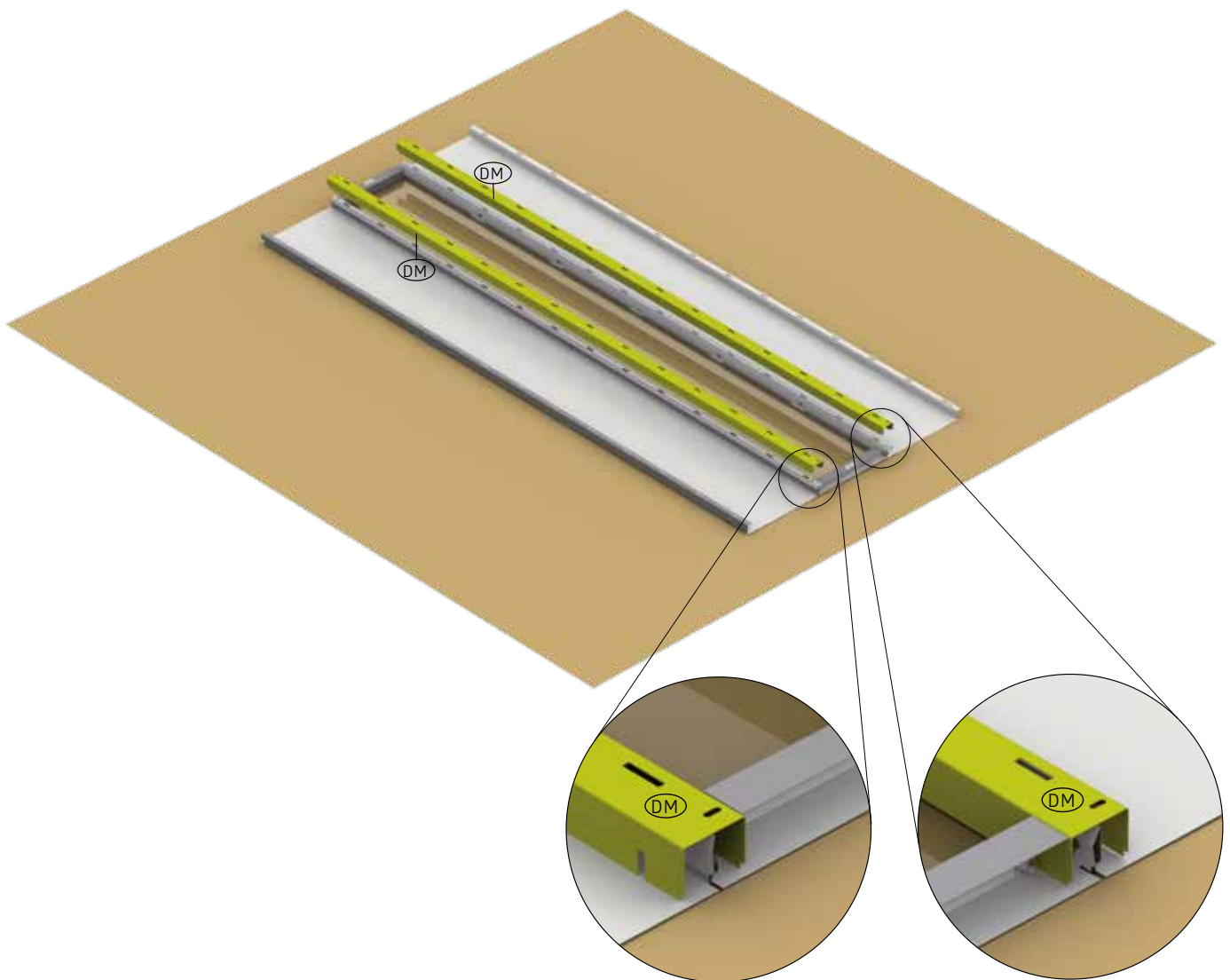
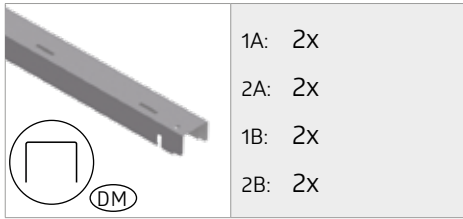





# 1.

## Rückwand

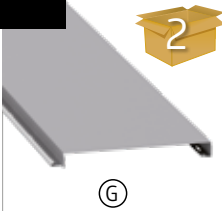
Rear wall - Paroi arrière - Achterwand - Panel posterior - Parete posteriore - Bagplade

 Ⓒ	 2	1A: 5X	 M5 x 10 Ⓓ1	 7	1A: 4X
		2A: 5X		2A: 4X	
		1B: 7X		1B: 6X	
		2B: 7X		2B: 6X	

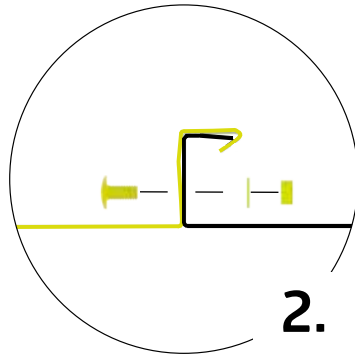
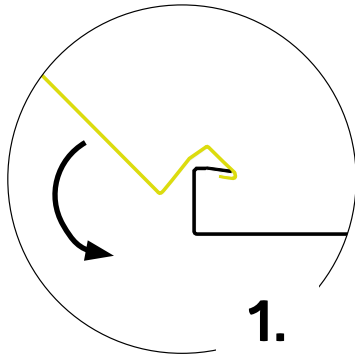

### Festziehen



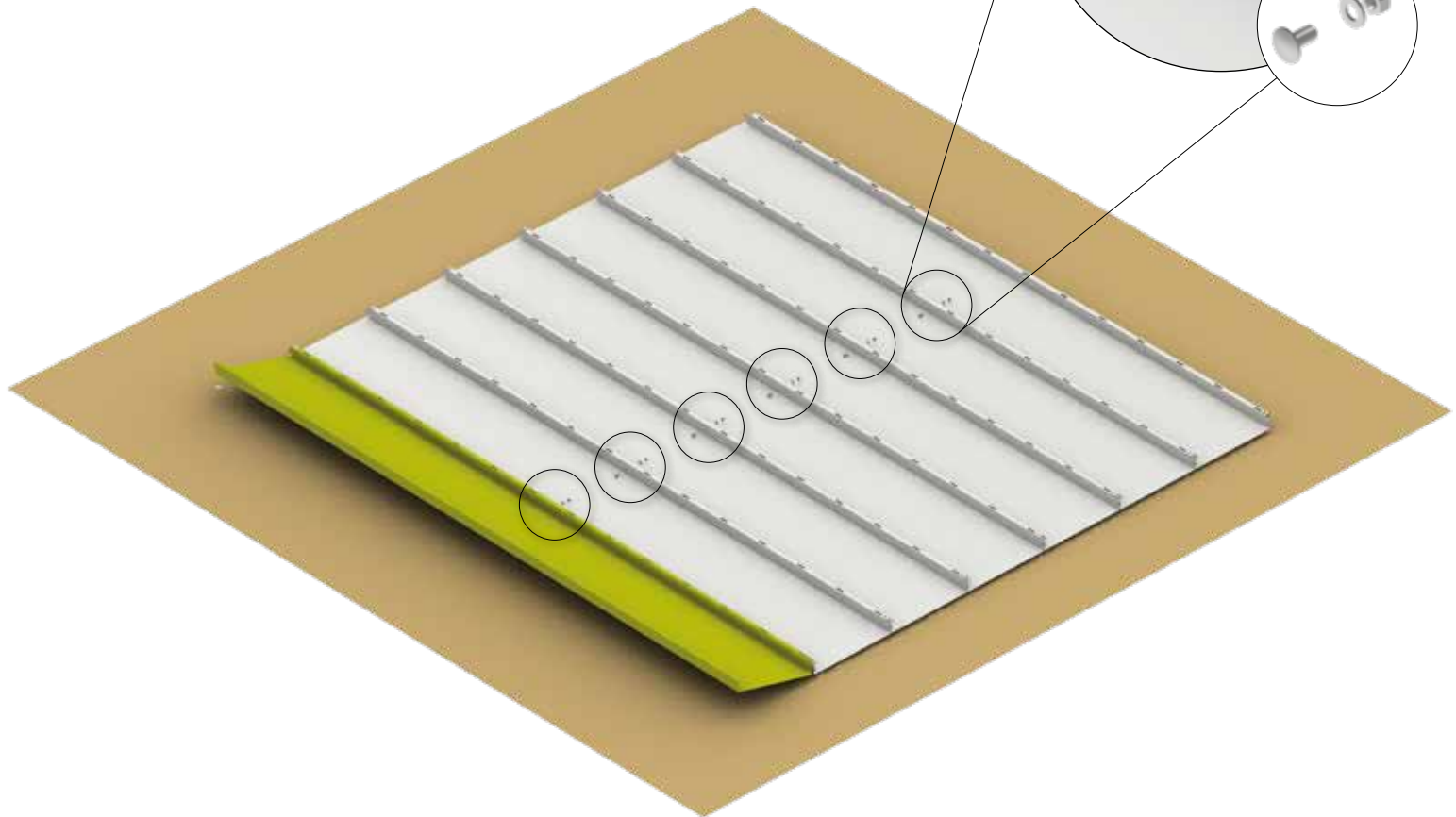
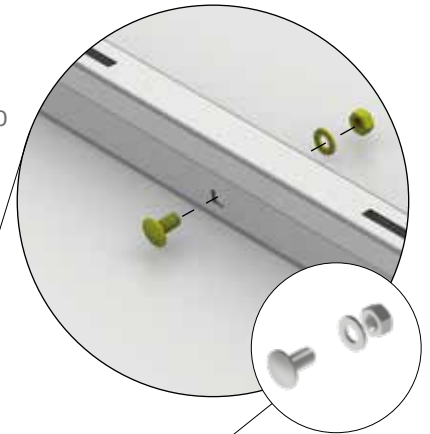

- ⒸB tighten
- ⒸR serrez fort
- ⒸNL vastdraaien
- ⒸES apriete
- ⒸIT serrare a fondo
- ⒸDK fastspænding



# 2.

## Rückwand

Rear wall - Paroi arrière - Achterwand - Panel posterior - Parete posteriore - Bagplade

		1A: 1X (1661 mm)			1A: 1X (1631 mm)
		2A: 1X (1661 mm)		2A: 1X (1631 mm)	
		1B: 1X (2221 mm)		1B: 1X (2191 mm)	
		2B: 1X (2221 mm)		2B: 1X (2191 mm)	

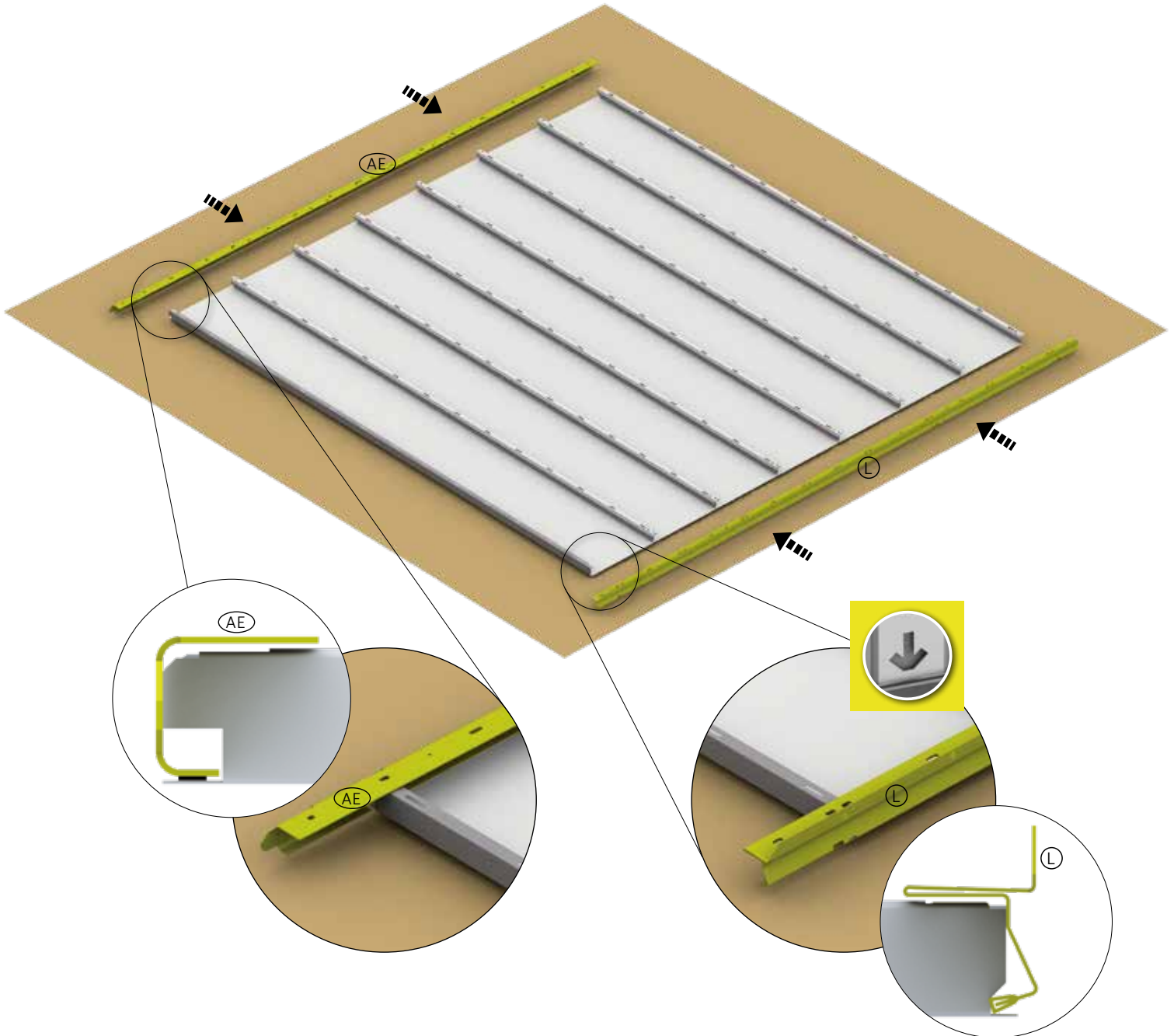

# 3.

## Rückwand

Rear wall - Paroi arrière - Achterwand - Panel posterior - Parete posteriore - Bagplade

M5 x 10



- 1A: 8x
- 2A: 8x
- 1B: 12x
- 2B: 12x

4,8 x 19



- 1A: 6x
- 2A: 6x
- 1B: 6x
- 2B: 6x

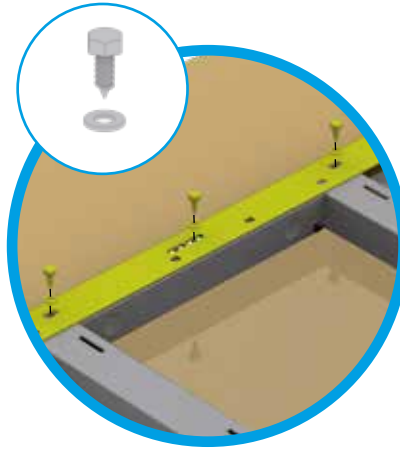
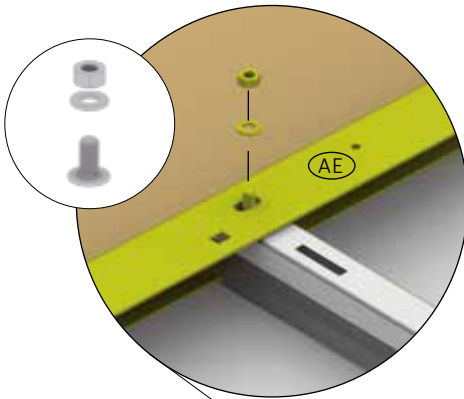

### Verschraubung Lichtpaneel

**(GB)** Screw connection for acrylic glass panel.

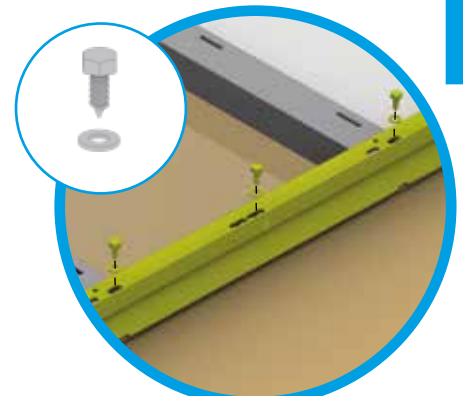
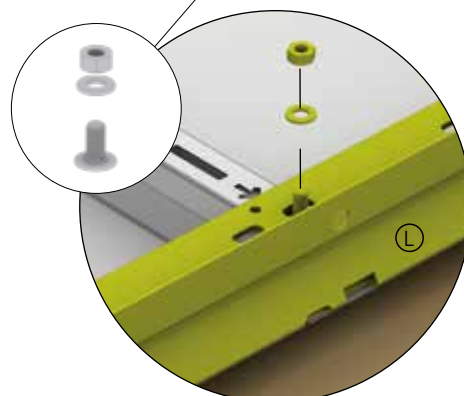
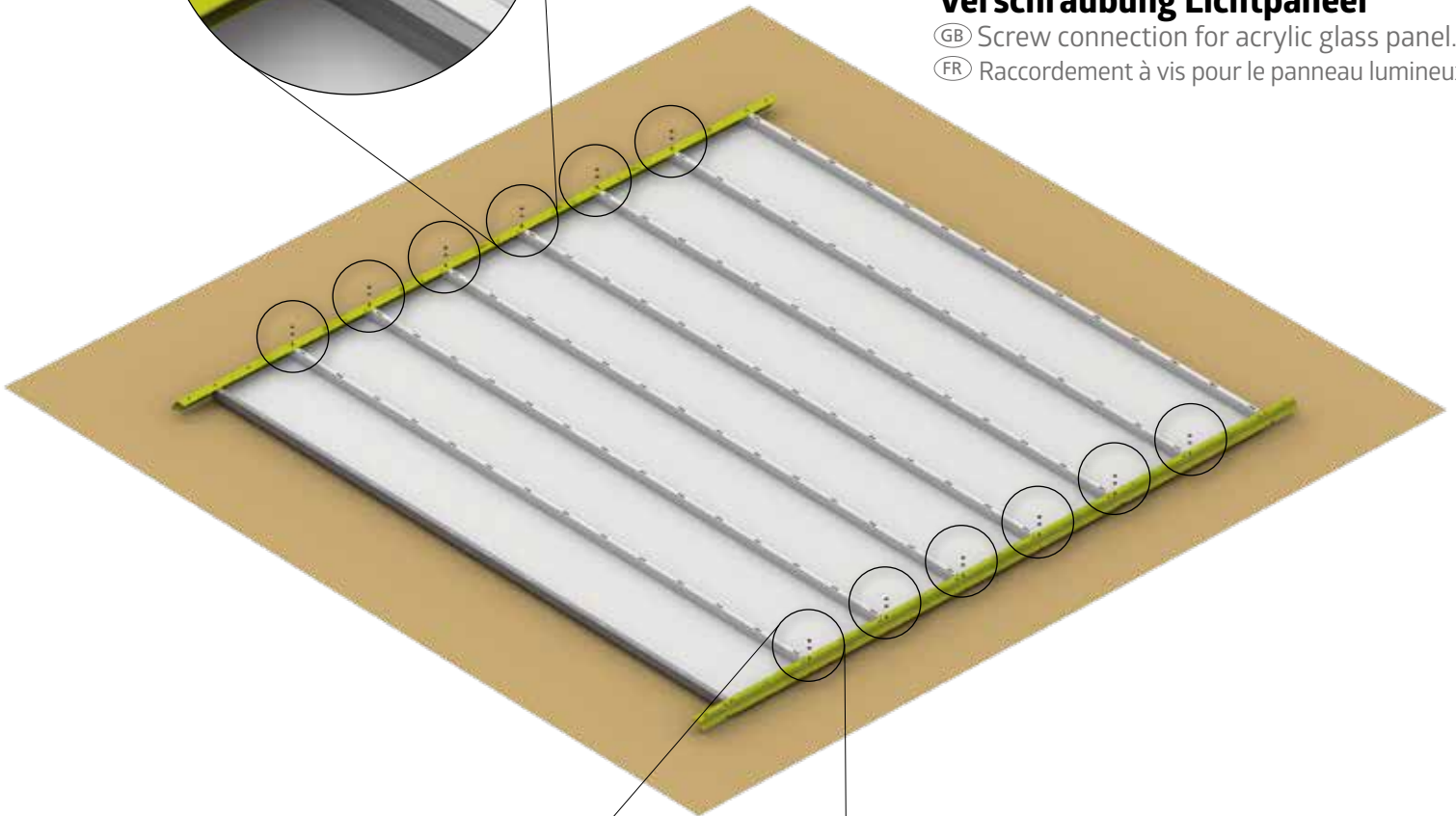

**(FR)** Raccordement à vis pour le panneau lumineux.



# 4.

## Seitenwand

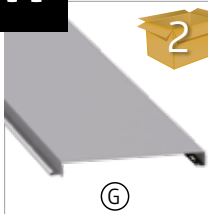
Side wall - Paroi latérale - Zijwand - panel lateral - Parete laterale - Sideplade

		1A: 10x			1A: 8x
		2A: 14x			2A: 12x
		1B: 10x			1B: 8x
		2B: 14x			2B: 12x

M5 x 10

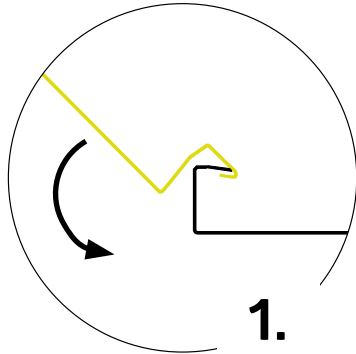

1.

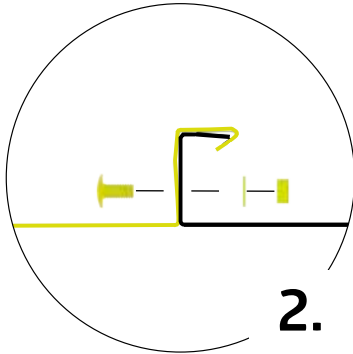

2.



### Festziehen

- ⒸGB tighten
- ⒸFR serrez fort
- ⒸNL vastdraaien
- ⒸES apriete
- ⒸIT serrare a fondo
- ⒸDK fastspænding

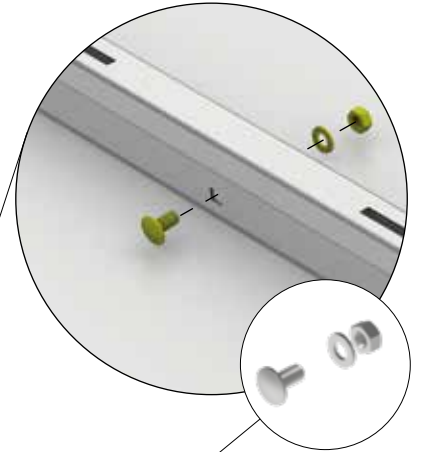

2x

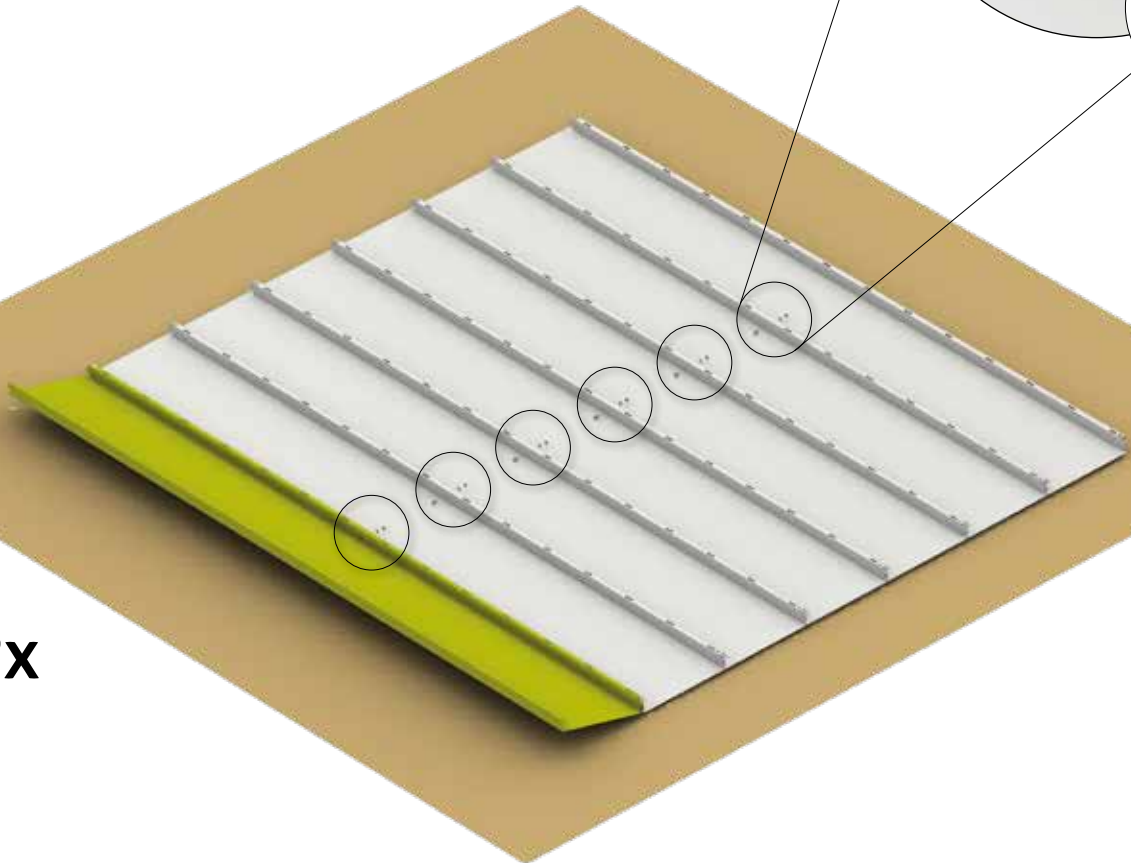







# 5.

## Seitenwand

Side wall - Paroi latérale - Zijwand - panel lateral - Parete laterale - Sideplade

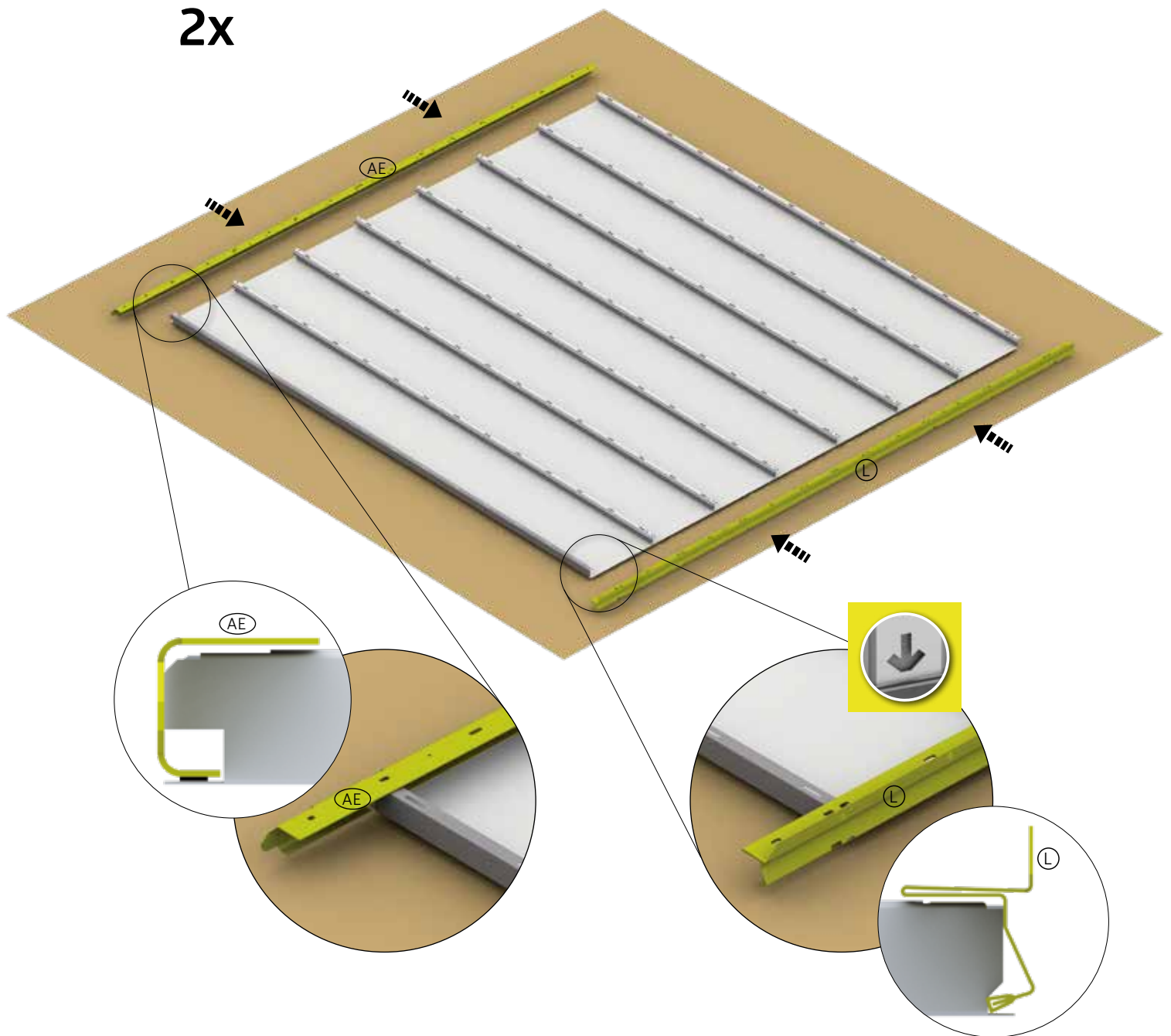

 	1A: 2X (1661 mm)	 	1A: 2X (1631 mm)
	2A: 2X (1661 mm)		2A: 2X (2191 mm)
	1B: 2X (2221 mm)		1B: 2X (1631 mm)
	2B: 2X (2221 mm)		2B: 2X (2191 mm)



# 6.

## Seitenwand

Side wall - Paroi latérale - Zijwand - panel lateral - Parete laterale - Sideplade

 <p>(AD)</p>	<p>7</p> <p>1A: 4x 2A: 4x 1B: 4x 2B: 4x</p>	<p>M5 x 10</p>  <p>(D1)</p>	<p>7</p> <p>1A: 20x 2A: 28x 1B: 20x 2B: 28x</p>	<p>4.8 x 19</p> 	<p>1A: 6x 2A: 6x 1B: 6x 2B: 6x</p>
---	---	--	---	---	--



### Verschraubung Lichtpaneel

(GB) Screw connection for acrylic glass panel.  
(FR) Raccordement à vis pour le panneau lumineux.

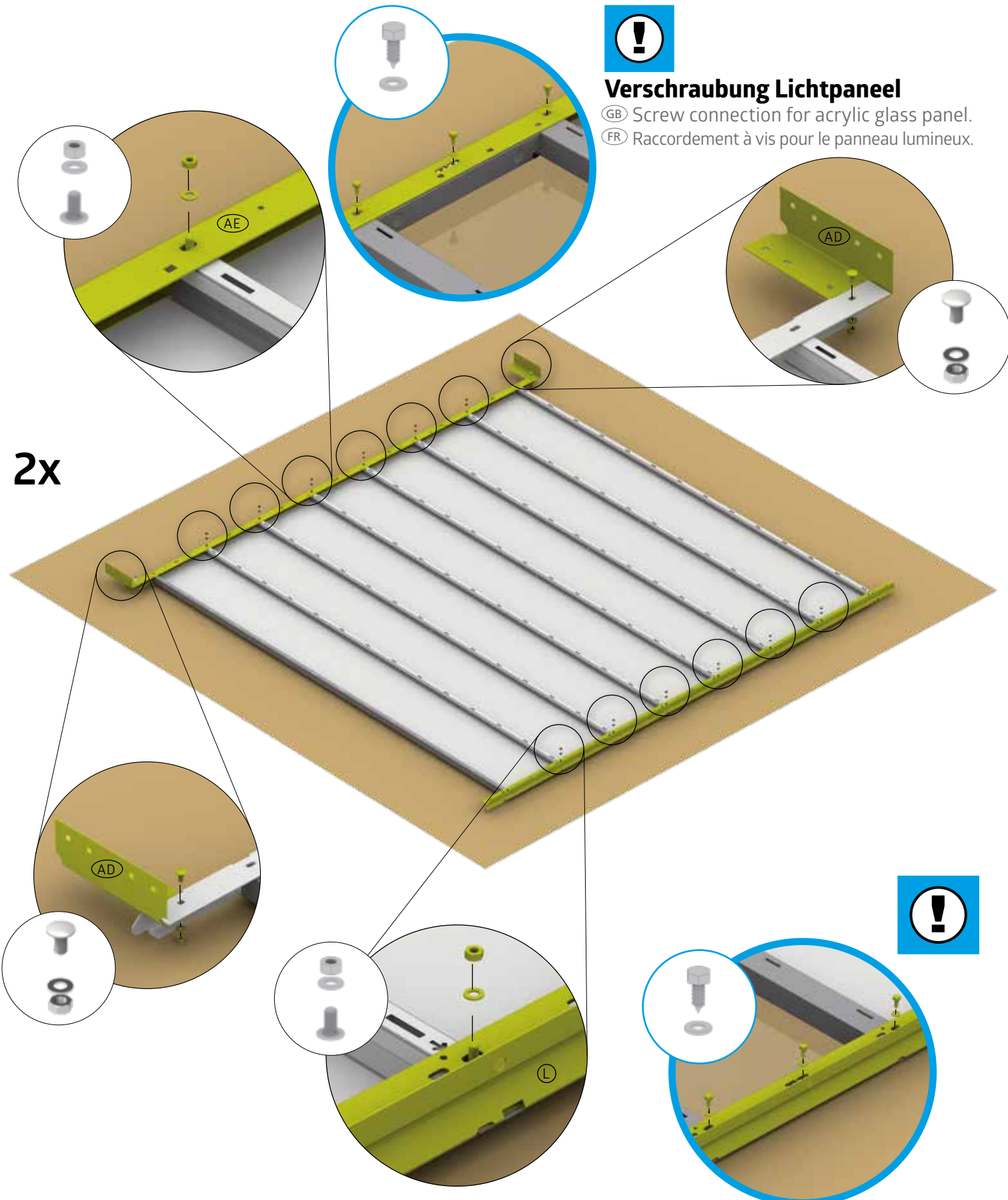









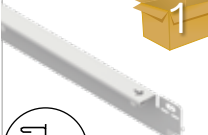

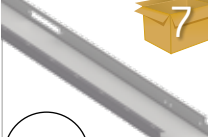

# Doppeltür Vorderwand

Double door - front wall - Double porte - paroi frontale - Dubbele deur - voorwand - Doble puerta - pared frontal - Doppia porta - parete anteriore - Dobbeldør - forvæg

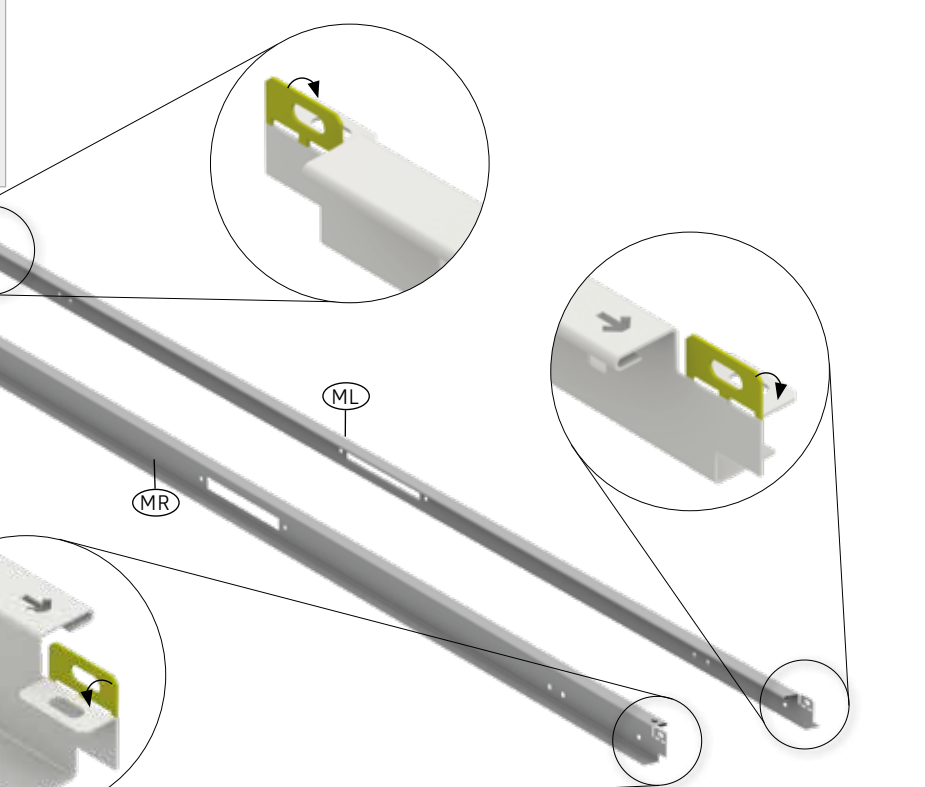
 	<p>1B: 1x 2B: 1x</p>	 	<p>1B: 1x 2B: 1x</p>	 	<p>1B: 1x 2B: 1x</p>
 	<p>1B: 1x 2B: 1x</p>				

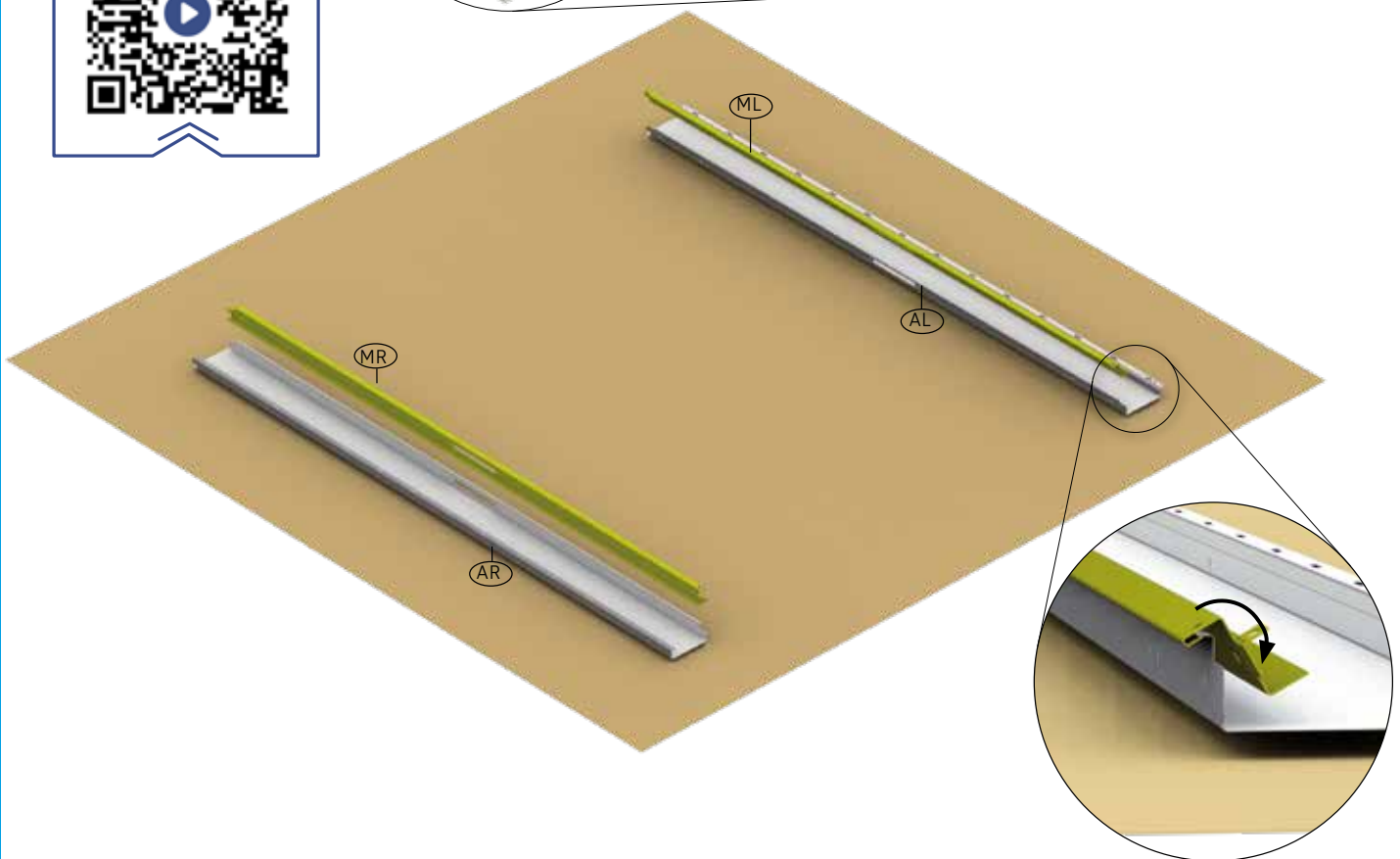



# Doppeltür Vorderwand

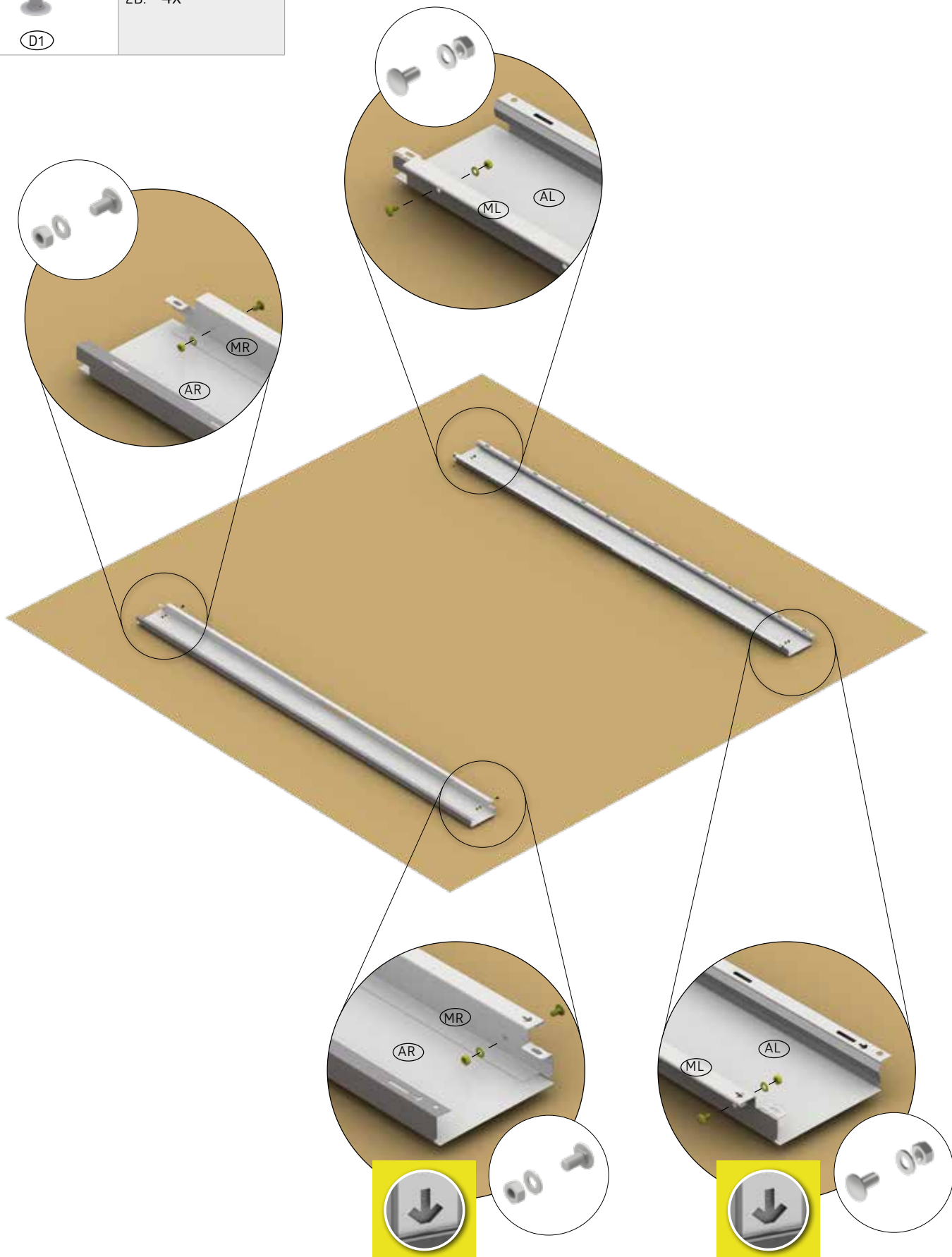

Double door - front wall - Double porte - paroi frontale - Dubbele deur - voorwand - Doble puerta - pared frontal - Doppia porta - parete anteriore - Dobbeldør - forvæg

M5 x 10		1B: 4x
		2B: 4x

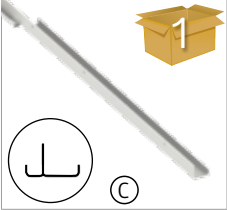
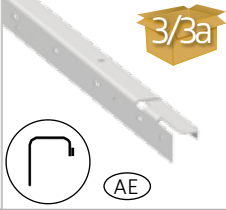

# Doppeltür Vorderwand

Double door - front wall - Double porte - paroi frontale - Dubbele deur - voorwand - Doble puerta - pared frontal - Doppia porta - parete anteriore - Dobbeldør - forvæg

 <p>1B: 1X (1619 mm) 2B: 1X (1619 mm)</p>	 <p>1B: 1x 2B: 1x</p>	 <p>M5 x 10</p>	<p>1B: 4x 2B: 4x</p>
---	--	---	--------------------------

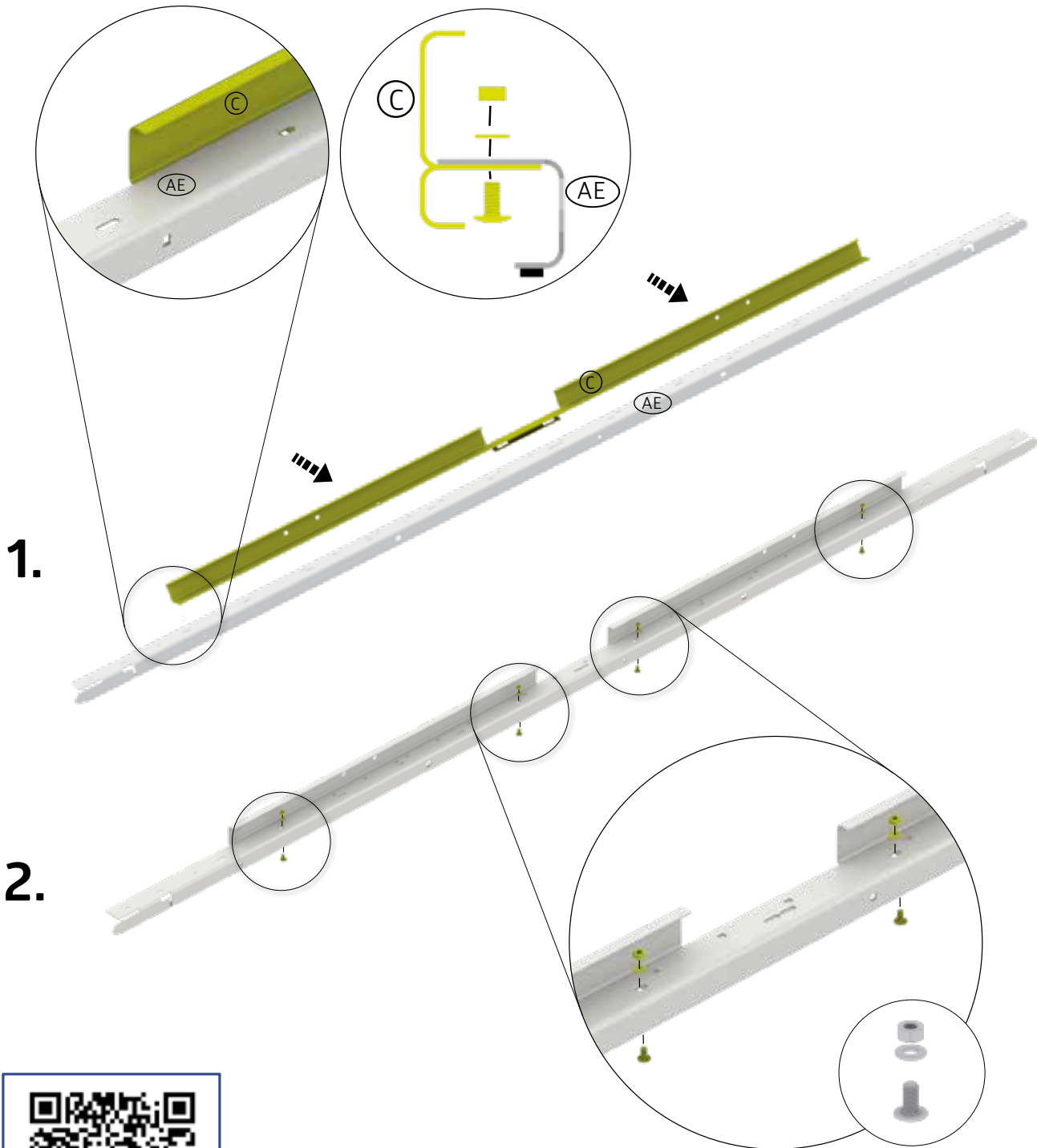

## Doppeltür Vorderwand

Double door - front wall - Double porte - paroi frontale - Dubbele deur - voorwand - Doble puerta - pared frontal - Doppia porta - parete anteriore - Dobbeldør - forvæg

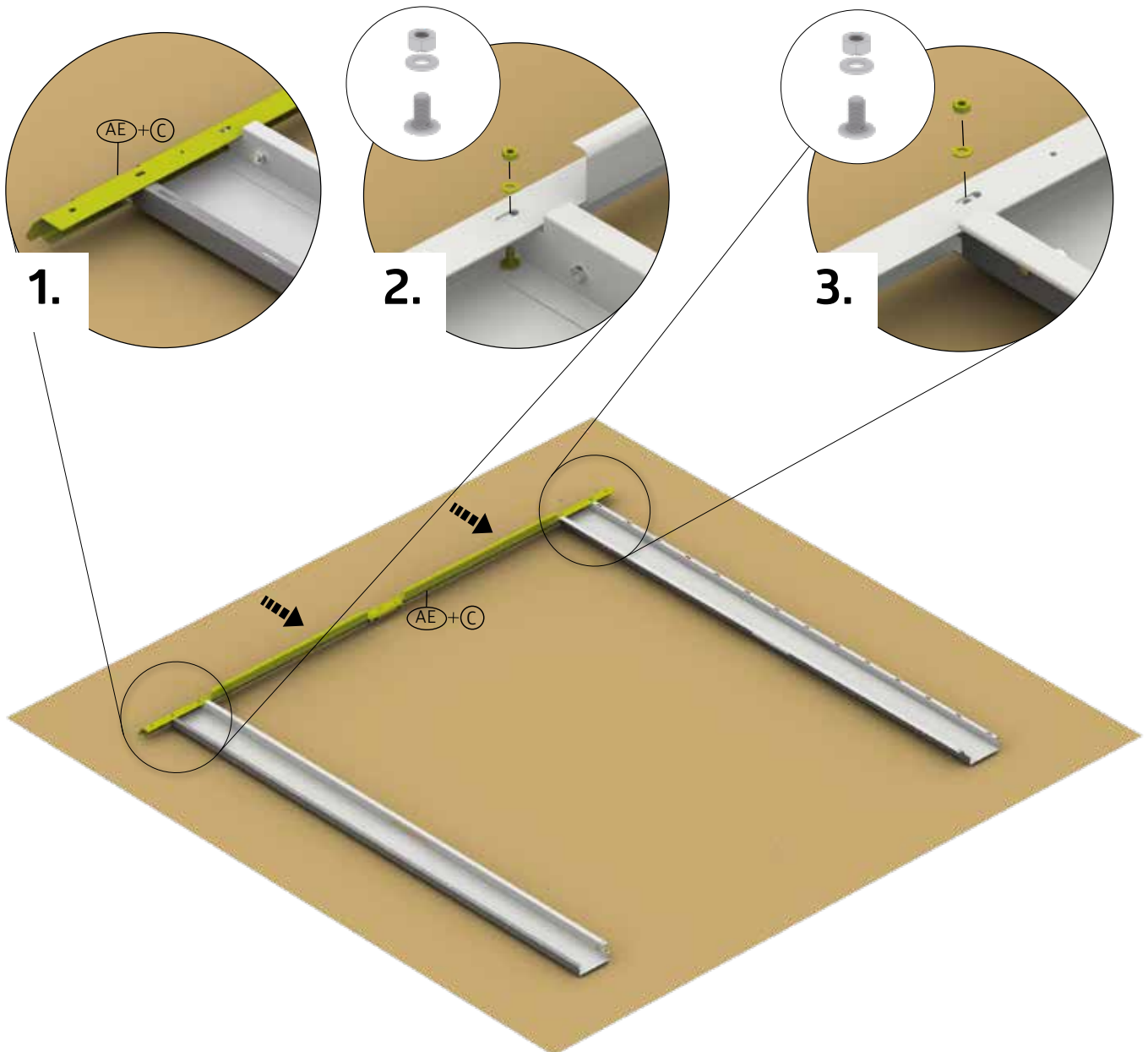
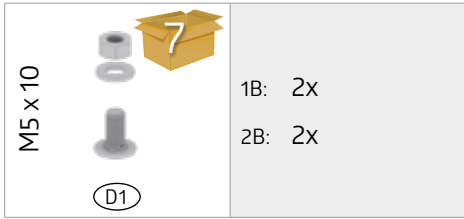

# Doppeltür Vorderwand

Double door - front wall - Double porte - paroi frontale - Dubbele deur - voorwand - Doble puerta - pared frontal - Doppia porta - parete anteriore - Dobbeldør - forvæg

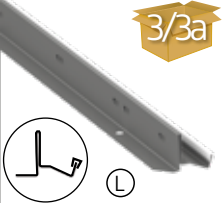
	1B: 1x		1B: 2x
	2B: 1x		2B: 2x

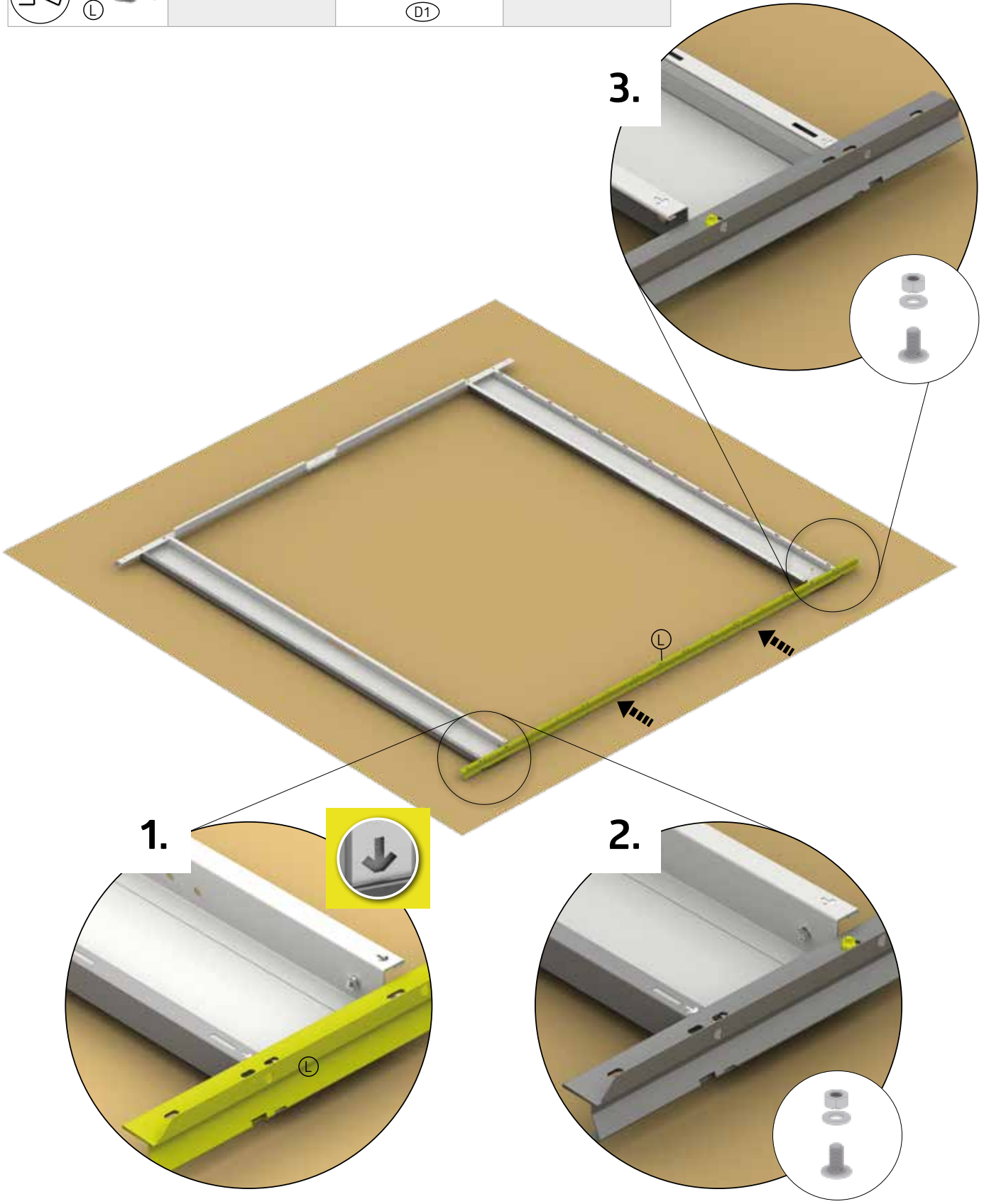



# 7.

## Standardtür - Vorderwand

Standard door - front wall - Porte standard - paroi frontale - Standaard deur - voorwand - Puerta estándar - pared frontal - Porta standard - parete anteriore - Standarddør - frontvæg

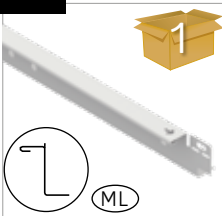
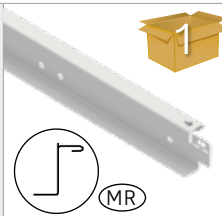
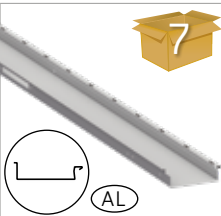
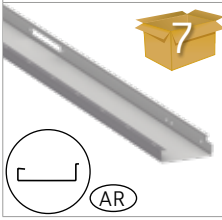
 <p>1A: 1x 2A: 1x 1B: 1x 2B: 1x</p> <p>ML</p>	 <p>1A: 1x 2A: 1x 1B: 1x 2B: 1x</p> <p>MR</p>	 <p>1A: 1x 2A: 1x 1B: 1x 2B: 1x</p> <p>AL</p>
 <p>1A: 1x 2A: 1x 1B: 1x 2B: 1x</p> <p>AR</p>		

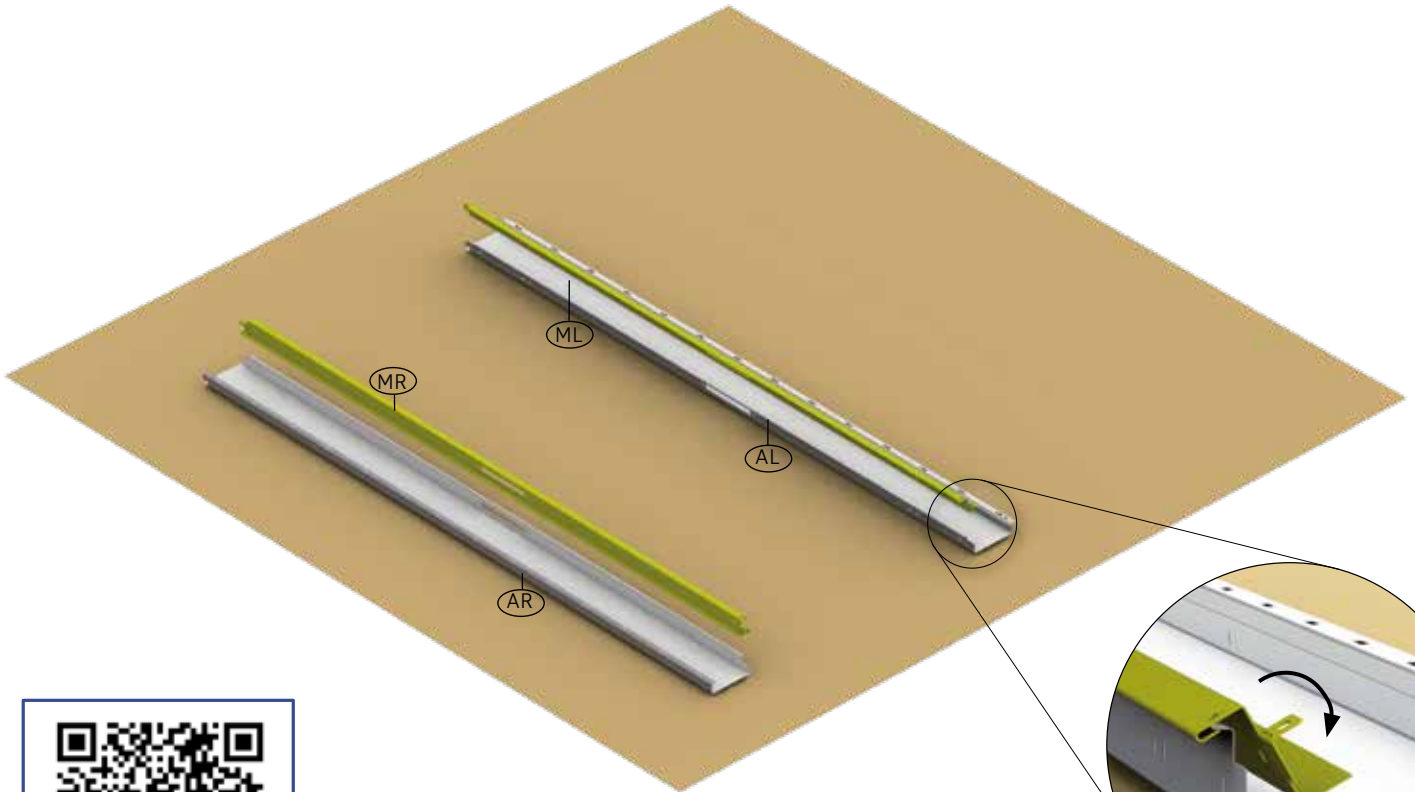
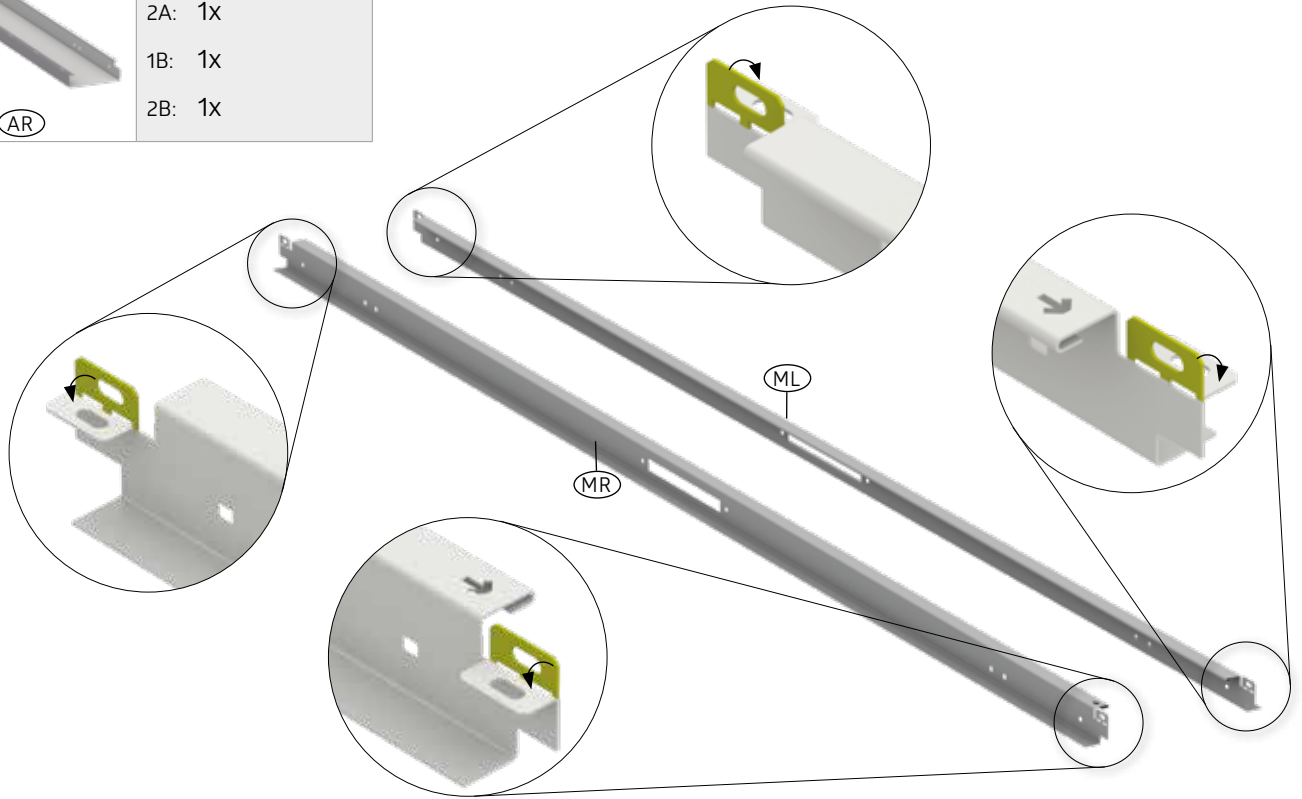







# 8.

## Standardtür - Vorderwand

Standard door - front wall - Porte standard - paroi frontale - Standaard deur - voorwand - Puerta estándar - pared frontal - Porta standard - parete anteriore - Standarddør - frontvæg



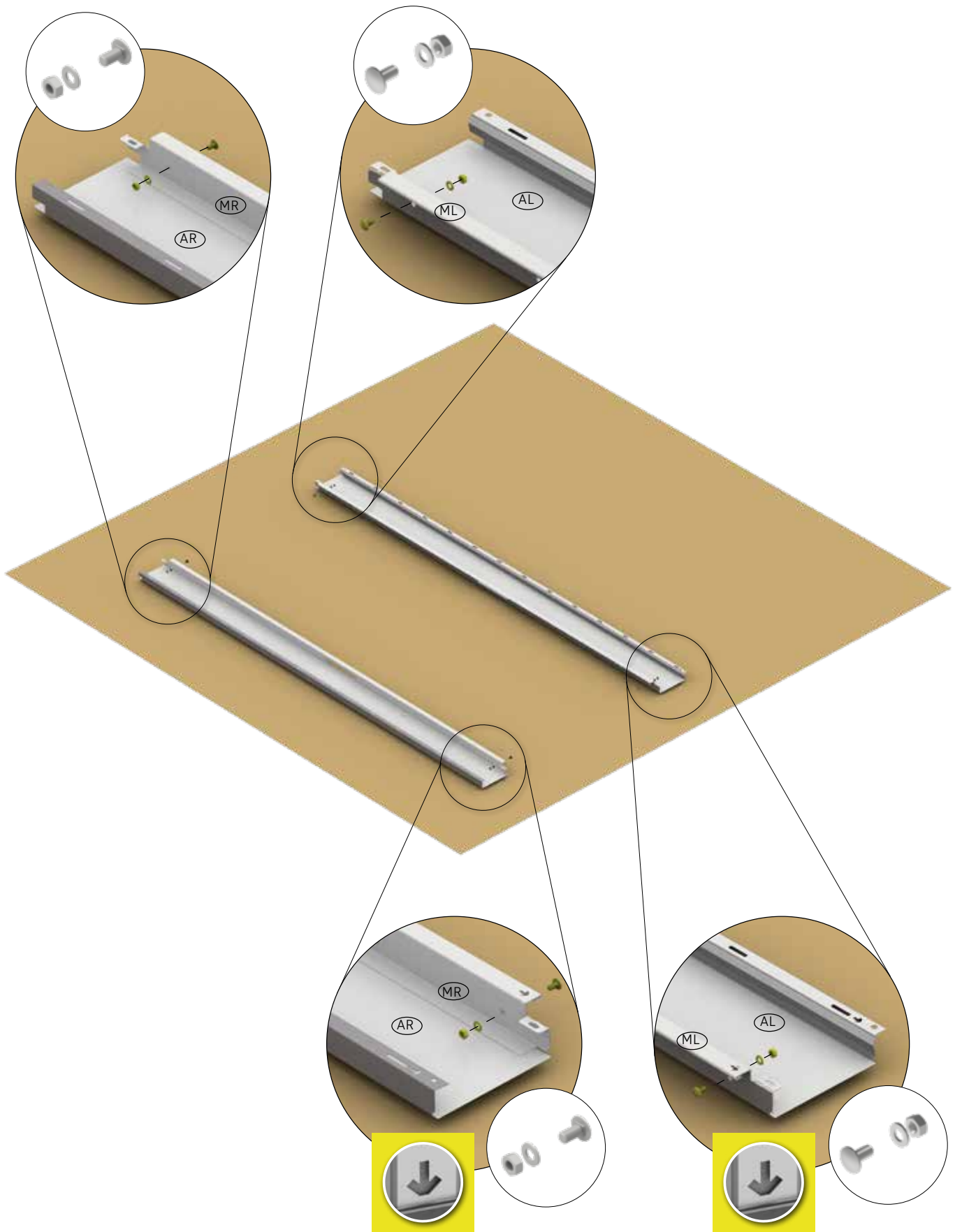

M5 x 10		1A: 4x
		2A: 4x
		1B: 4x
		2B: 4x

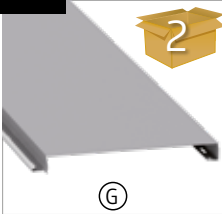

# 9.

## Standardtür - Vorderwand

Standard door - front wall - Porte standard - paroi frontale - Standaard deur - voorwand - Puerta estándar - pared frontal - Porta standard - parete anteriore - Standarddør - frontvæg

		1A: 1x			1A: 1x
	2A: 1x	2A: 1x			
	1B: 3x	1B: 3x			
	2B: 3x	2B: 3x			

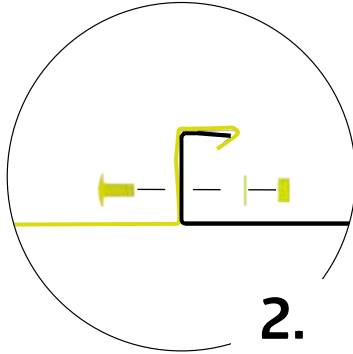
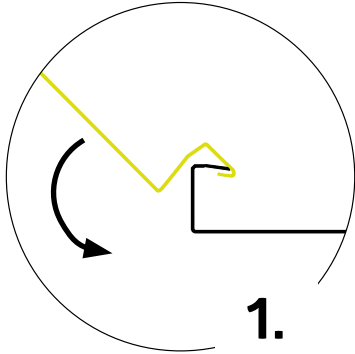

### Festziehen

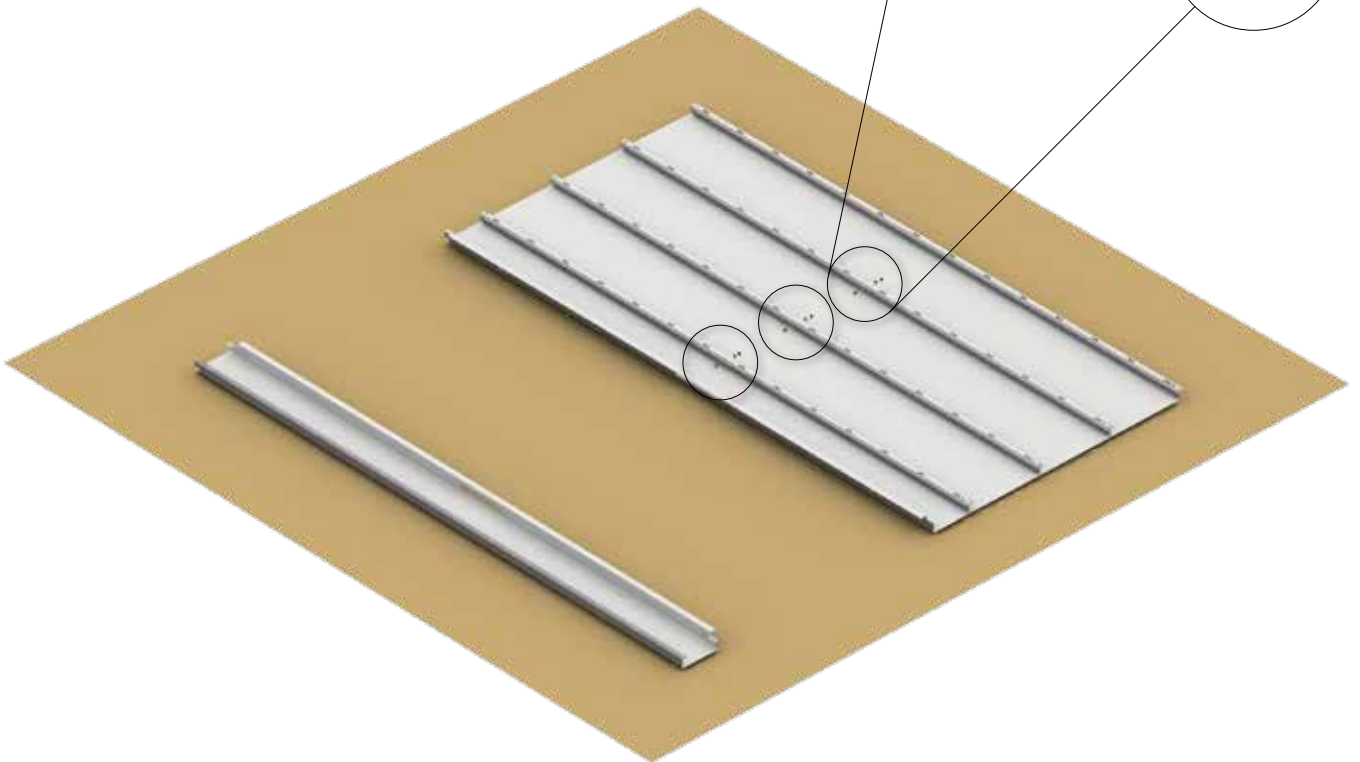
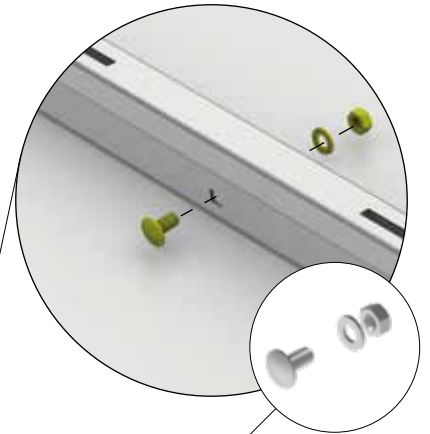

- ⒸGB tighten
- ⒸFR serrez fort
- ⒸNL vastdraaien
- ⒸES apriete
- ⒸIT serrare a fondo
- ⒸDK fastspænding



# 10.

## Standardtür - Vorderwand

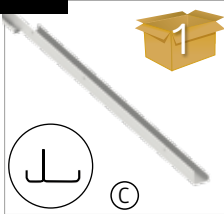
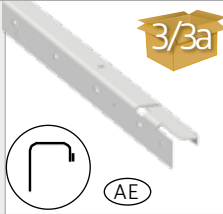
Standard door - front wall - Porte standard - paroi frontale - Standaard deur - voorwand - Puerta estándar - pared frontal - Porta standard - parete anteriore - Standarddør - frontvæg



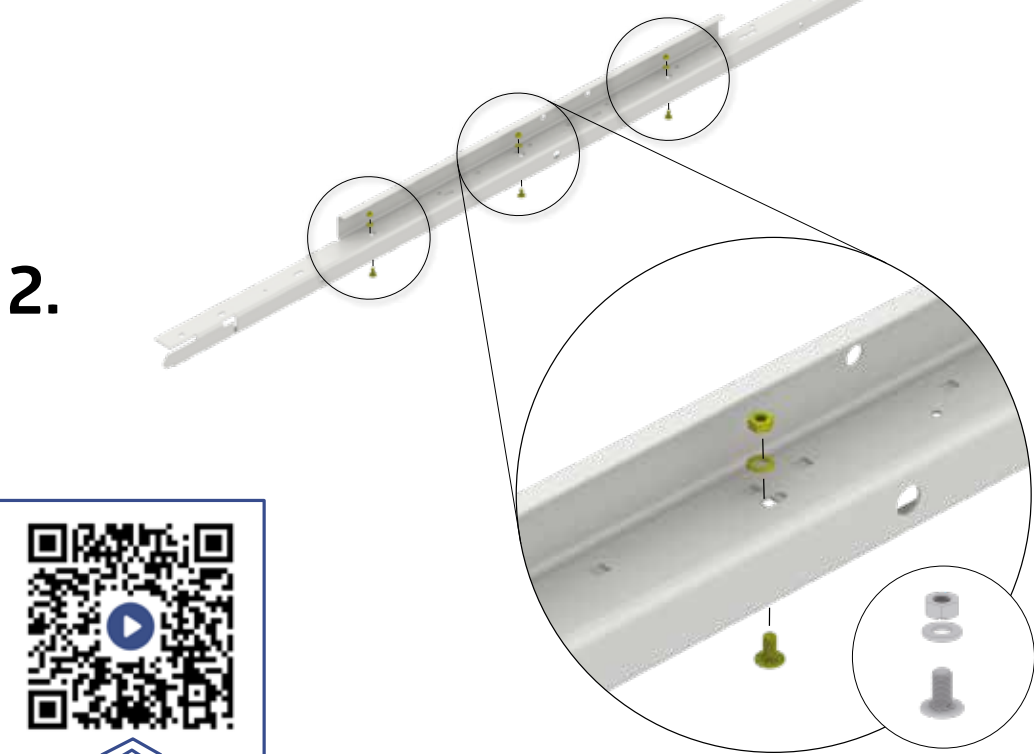
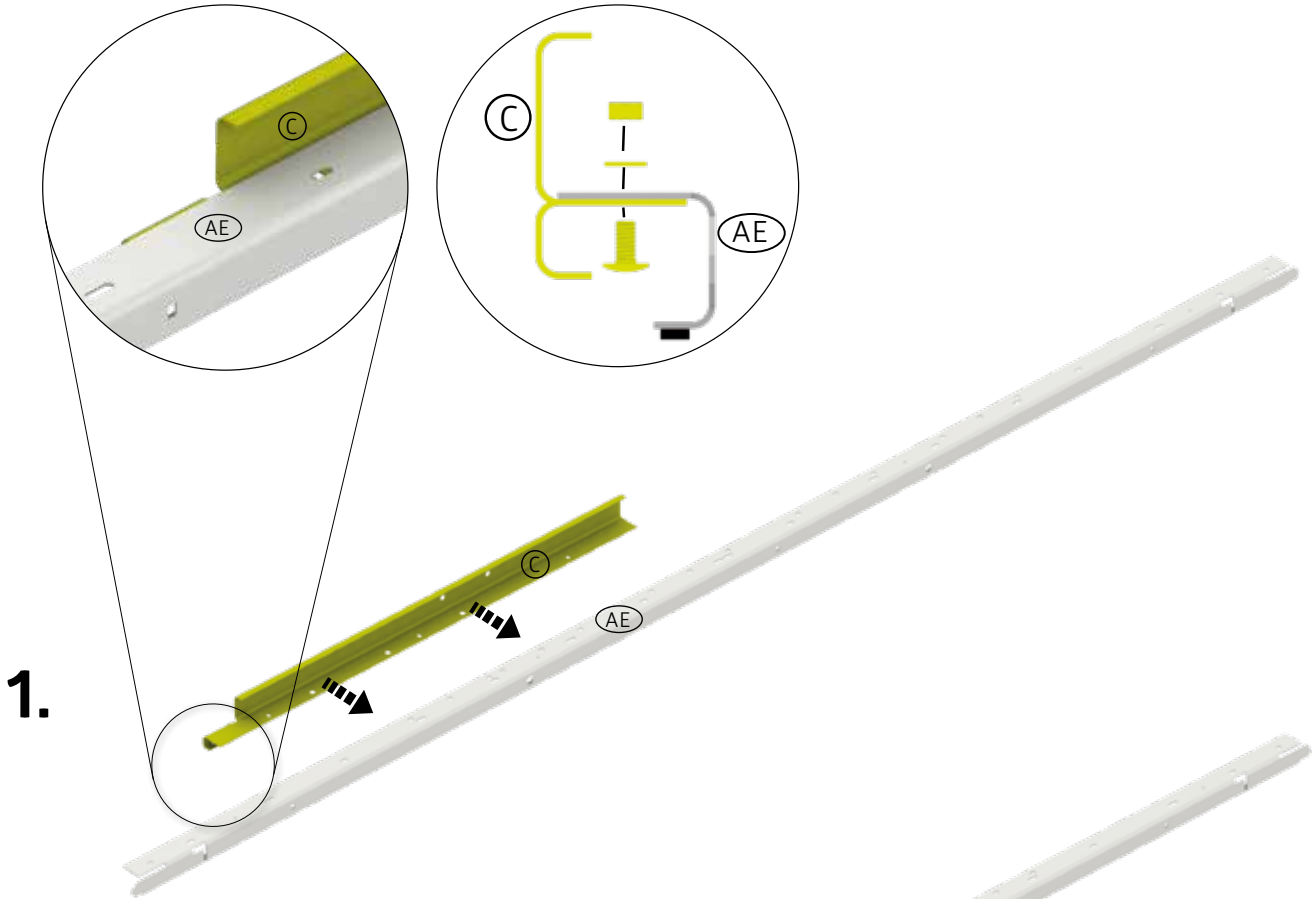

 <p>1</p> <p>Ⓢ</p>	<p>1A: 1x 2A: 1x 1B: 1x 2B: 1x</p>	 <p>3/3a</p> <p>Ⓢ</p>	<p>1A: 1x 2A: 1x 1B: 1x 2B: 1x</p>	<p>M5 x 10</p>  <p>7</p> <p>Ⓢ</p>	<p>1A: 3x 2A: 3x 1B: 3x 2B: 3x</p>
--	--	--	--	--	--



# 11.

## Standardtür - Vorderwand

Standard door - front wall - Porte standard - paroi frontale - Standaard deur - voorwand - Puerta estándar - pared frontal - Porta standard - parete anteriore - Standarddør - frontvæg



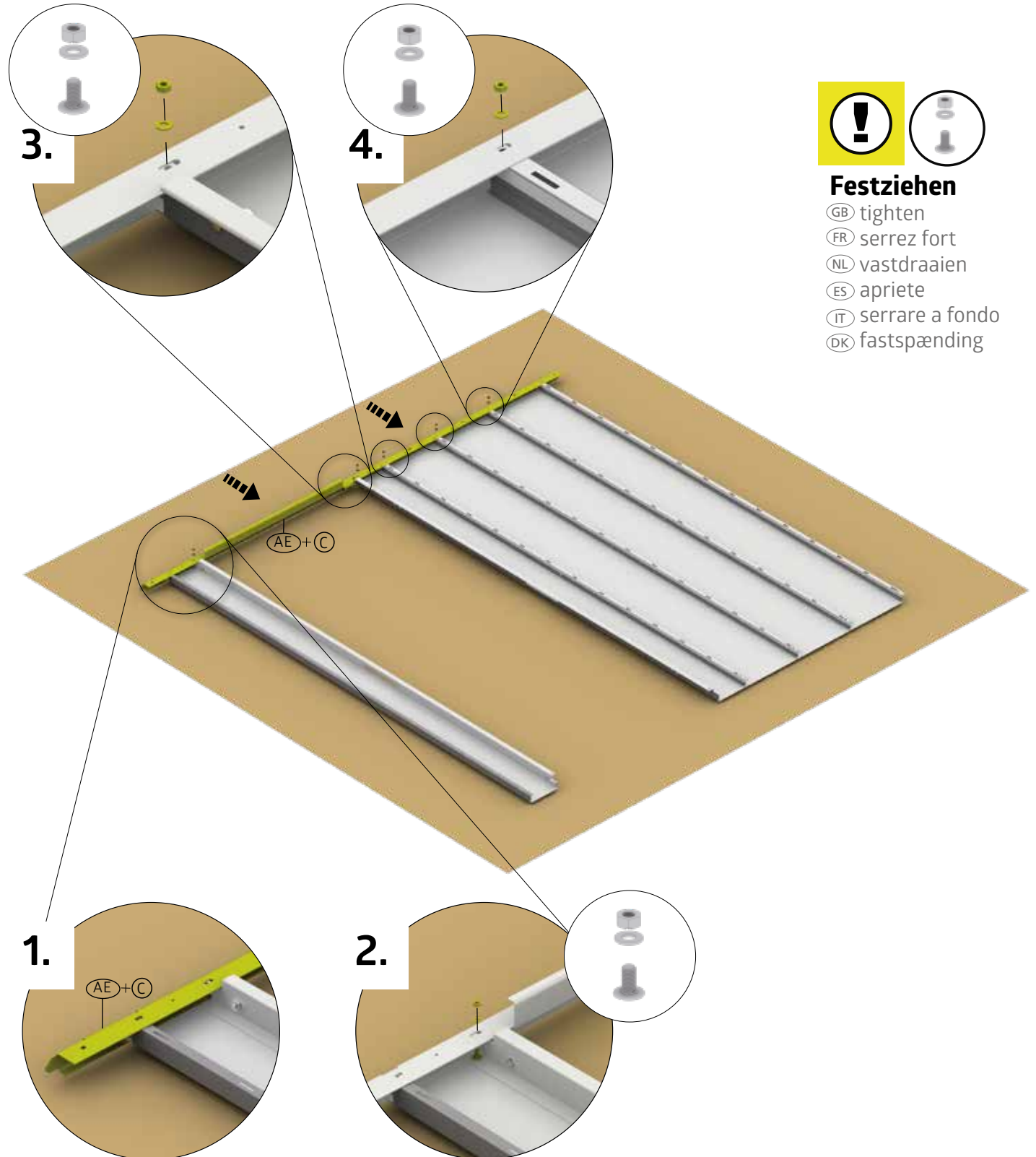



M5 x 10 D1		1A: 3x
		2A: 3x
		1B: 5x
		2B: 5x

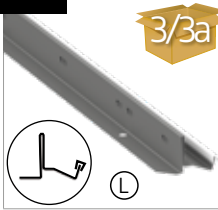

# 12.







## Standardtür - Vorderwand

Standard door - front wall - Porte standard - paroi frontale - Standaard deur - voorwand - Puerta estándar - pared frontal - Porta standard - parete anteriore - Standarddør - frontvæg

 	 1A: 1x 2A: 1x 1B: 1x 2B: 1x	M5 x 10   	 1A: 3x 2A: 3x 1B: 5x 2B: 5x
--	---	--	---



### Festziehen

-  tighten
-  serrez fort
-  vastdraaien
-  apriete
-  serrare a fondo
-  fastspænding

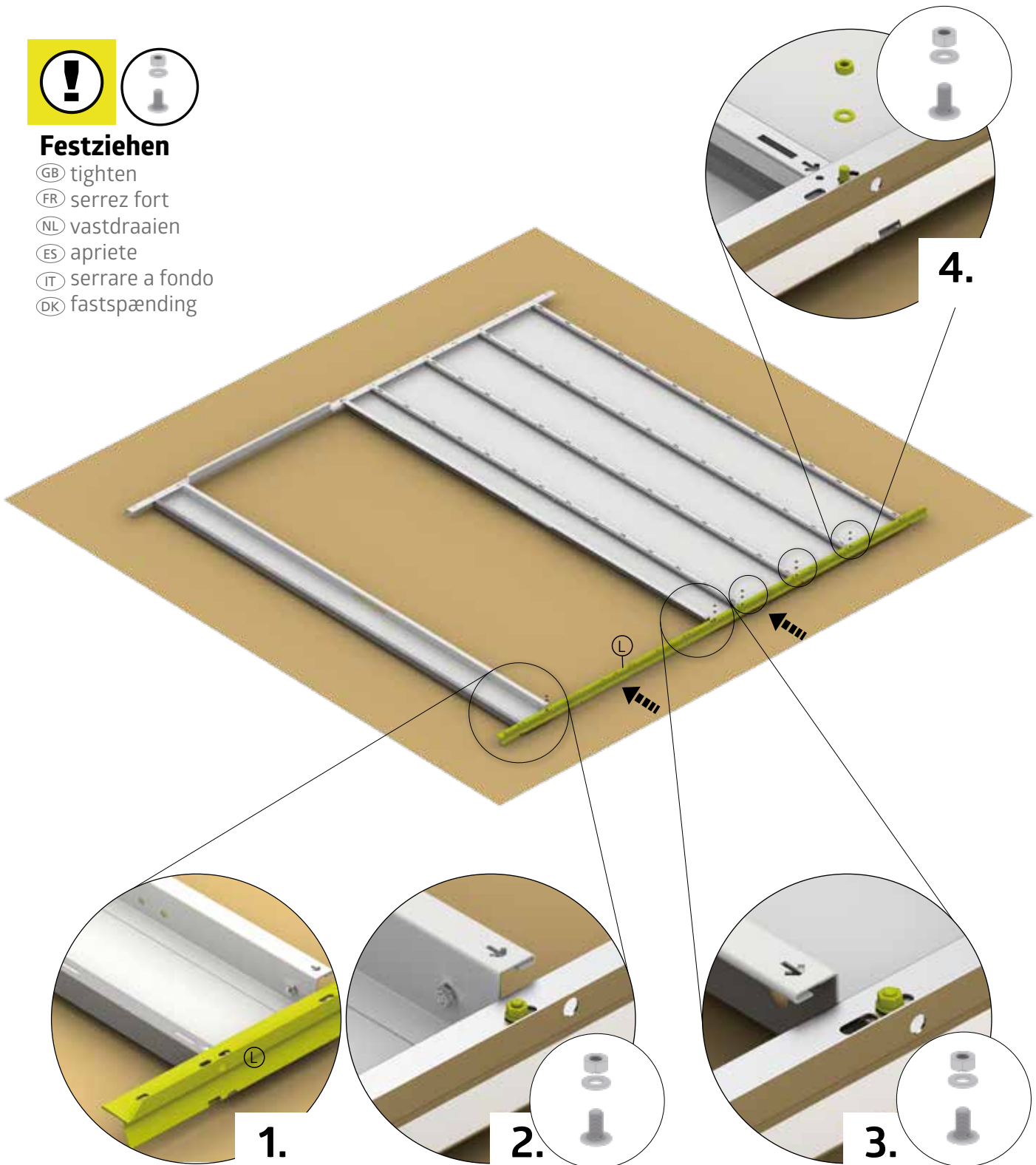







# Bodenrahmen

Floor frame - Cadre de sol - Bodemframe - Marco de suelo - Telaio perimetrale - Bundramme



 <p>(ZB)</p>	1A: 4X (1580 mm)	 <p>(ZC)</p>	1A: 4X
	2A: 2X (1580 mm) 2X (2140 mm)		2A: 4X
	1B: 2X (2140 mm) 2X (1580 mm)		1B: 4X
	2B: 4X (2140 mm)		2B: 4X

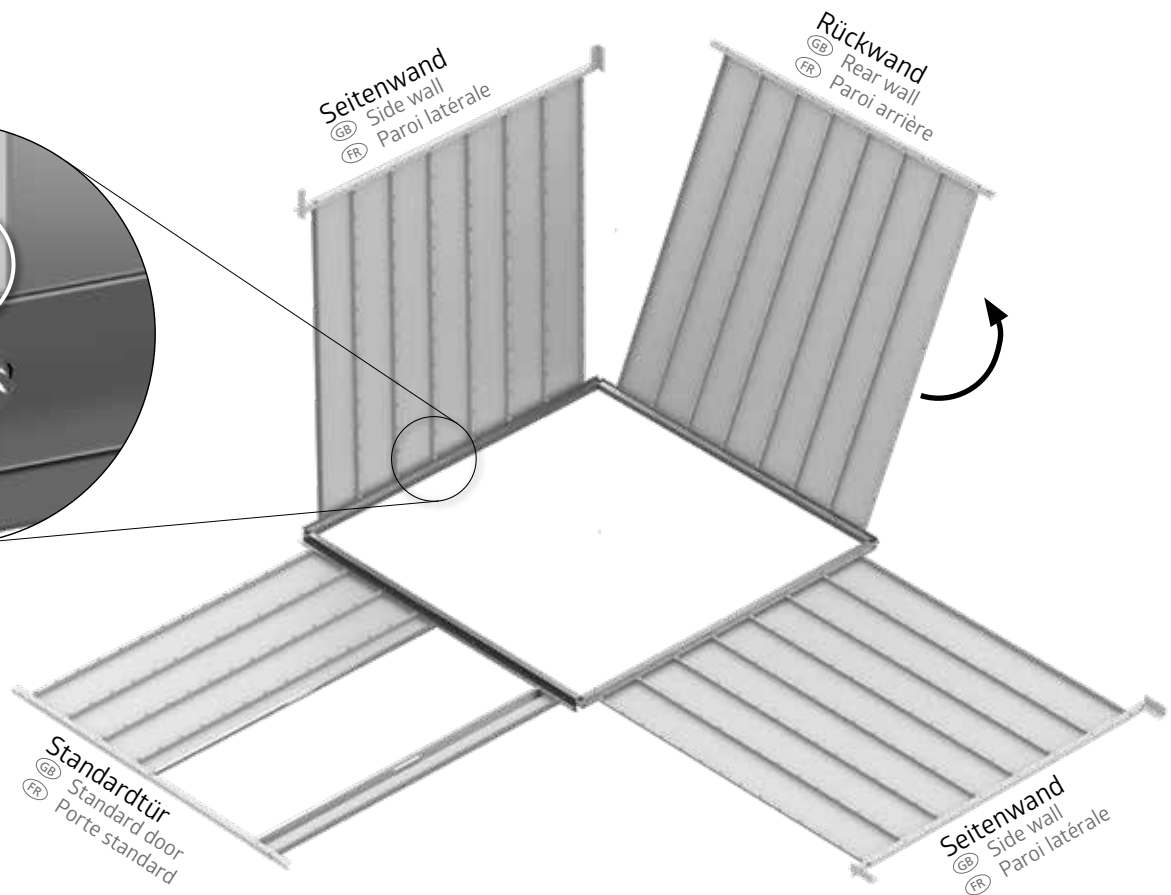
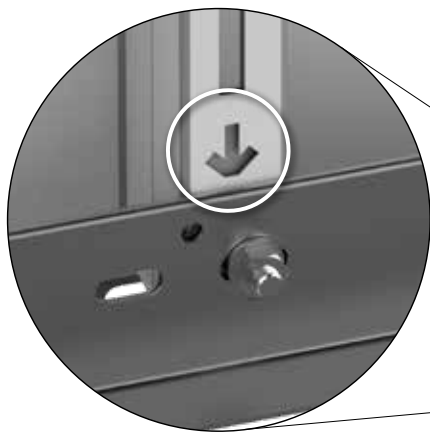
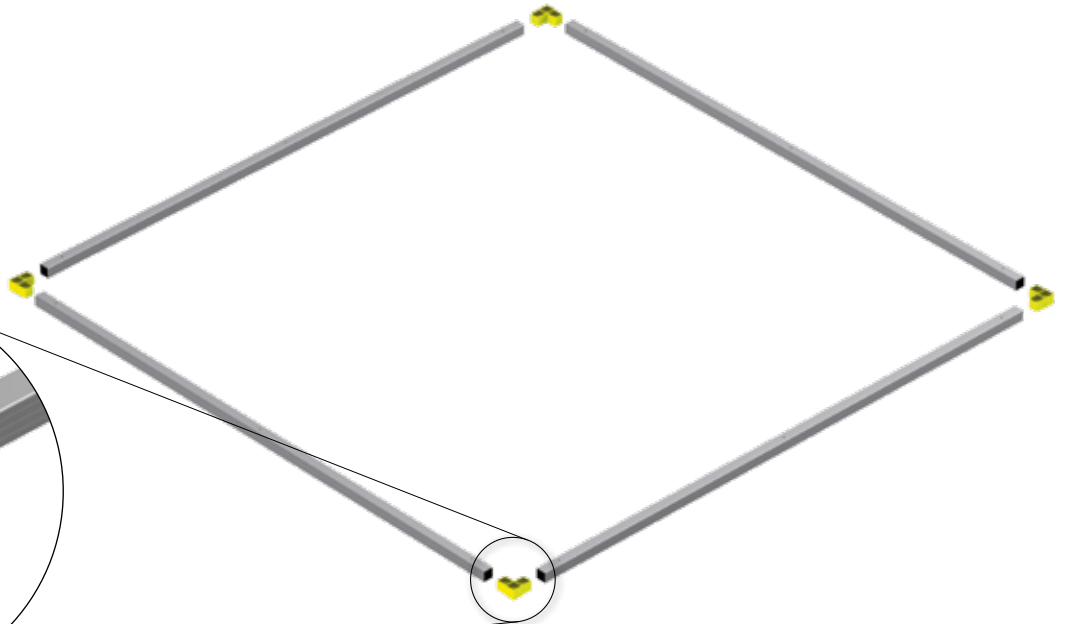
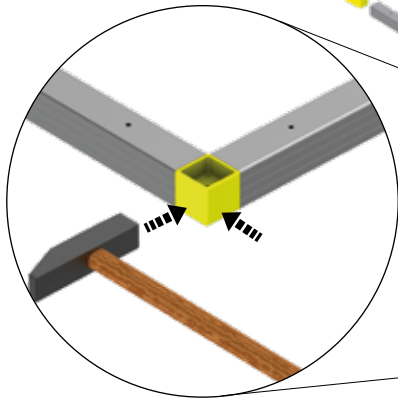

## Lochseite oben

- (GB) Hole side up
- (FR) Trou côté supérieur



 (ZD)	1A: 7x 2A: 7x 1B: 7x 2B: 7x	6.3 x 22  (ZF)	1A: 11x 2A: 11x 1B: 11x 2B: 11x	 (LB)	1A: 4x 2A: 4x 1B: 4x 2B: 4x
--	--------------------------------------	---	--	--	--------------------------------------

M5 x 10  (D1)	1A: 12x 2A: 12x 1B: 12x 2B: 12x
--	--

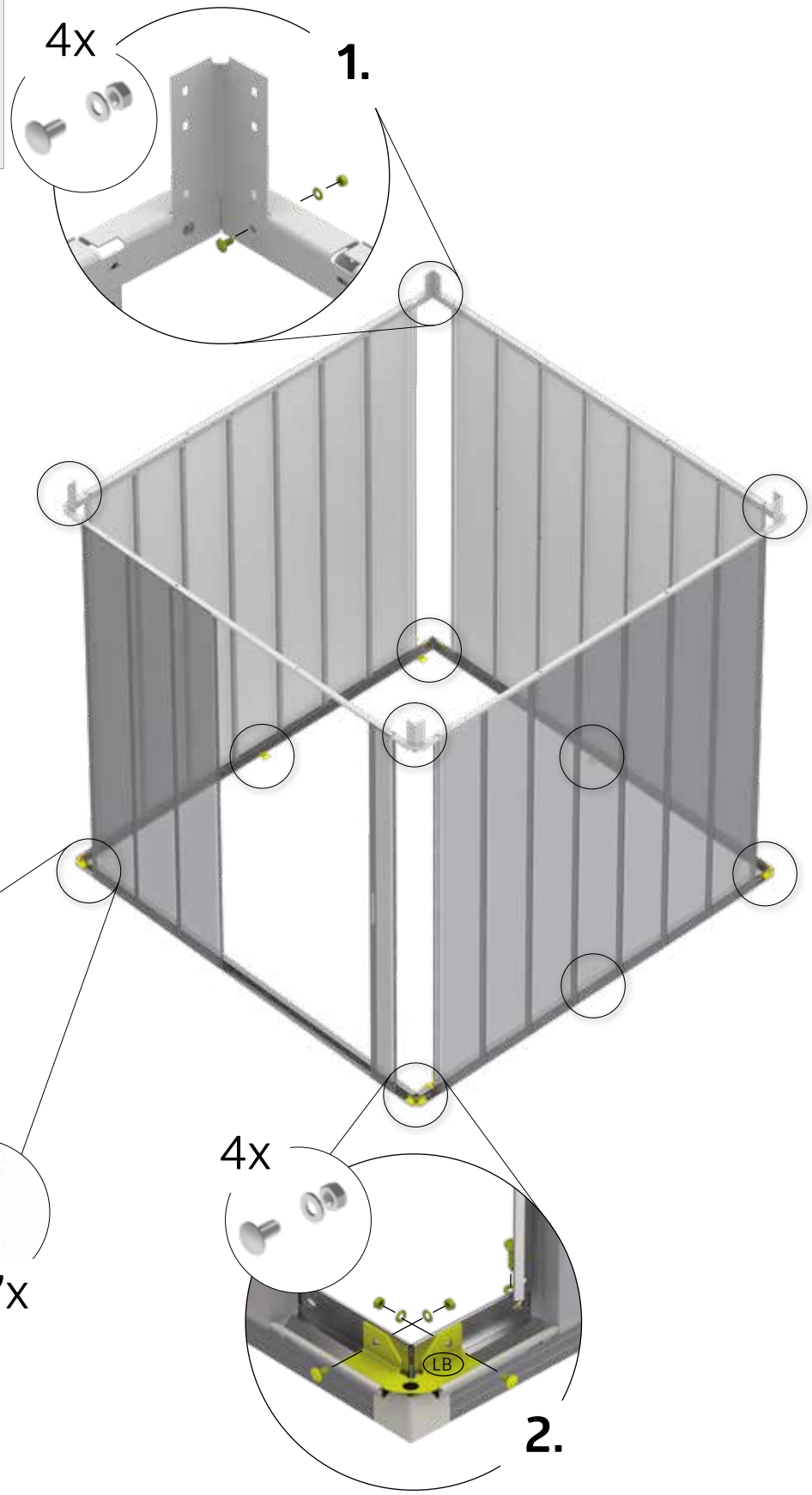

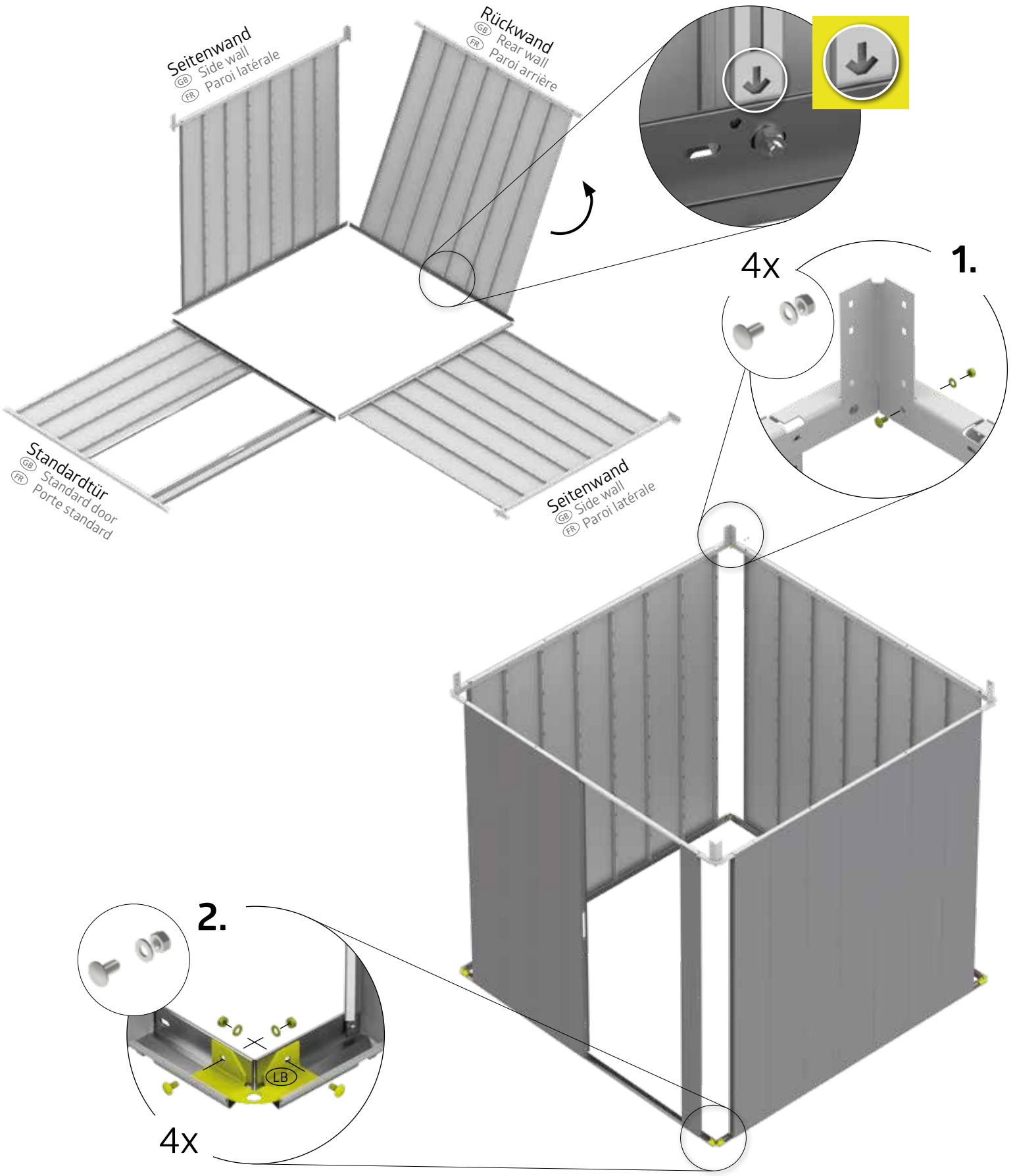

# 13.

 (LB)	 1A: 4x	M5 x 10  (D1)	 1A: 12x
	2A: 4x		2A: 12x
	1B: 4x		1B: 12x
	2B: 4x		2B: 12x

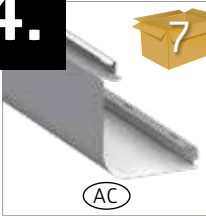

# 14.

 AC	 1A: 4x 2A: 4x 1B: 4x 2B: 4x	M5 x 10	 D1 1A: 8x 2A: 8x 1B: 8x 2B: 8x
---	--	---------	--

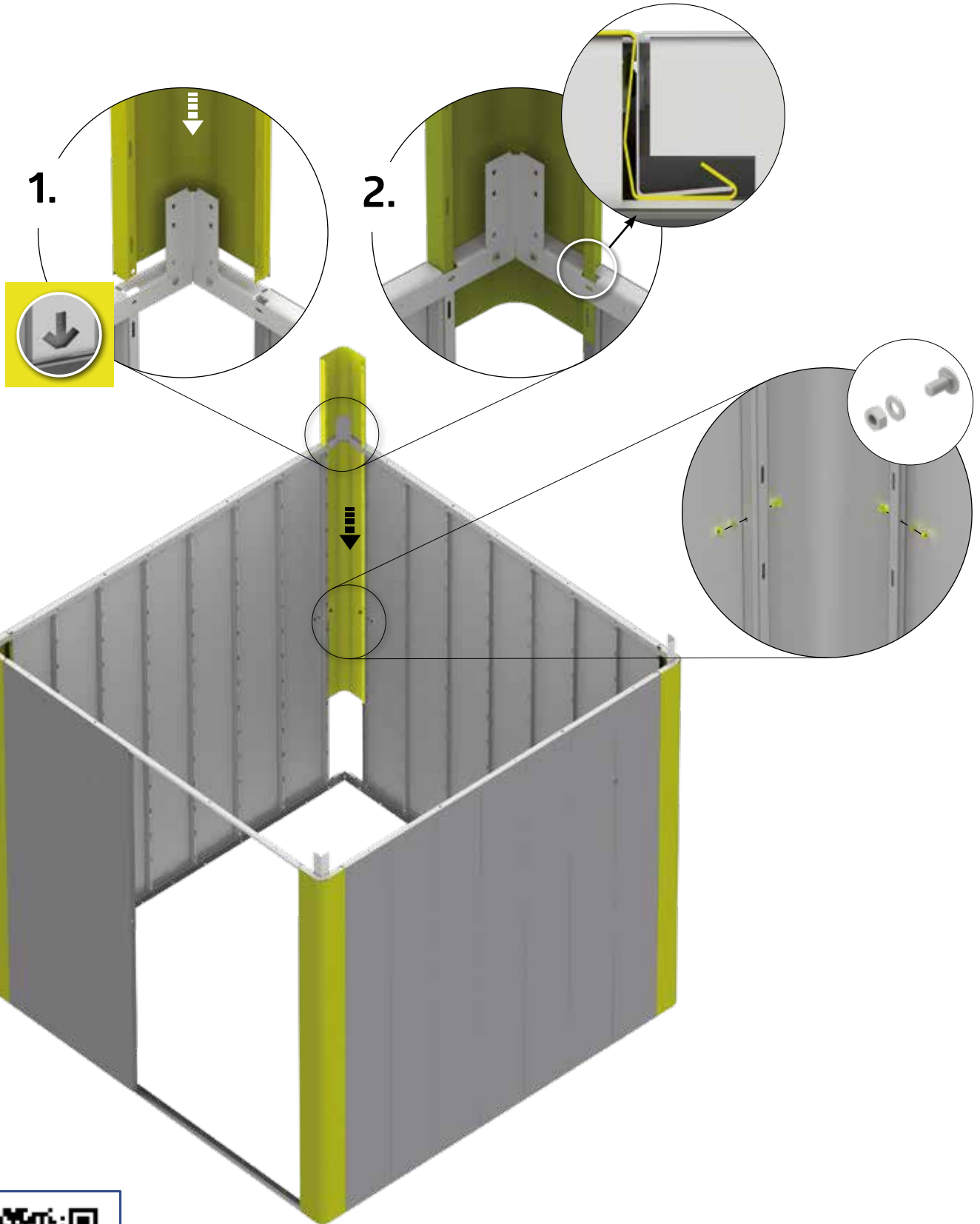

# 15.

M5 x 10



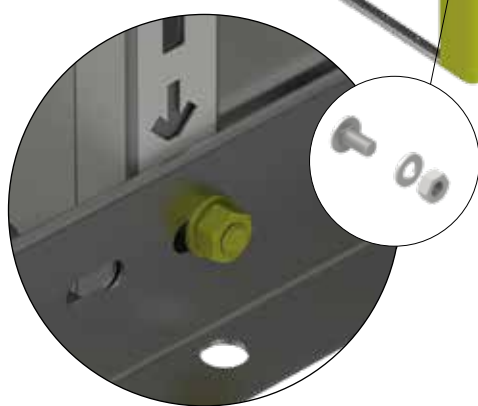
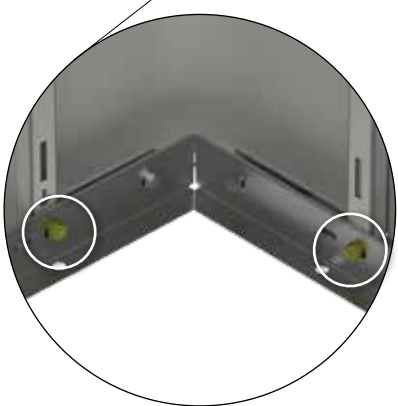
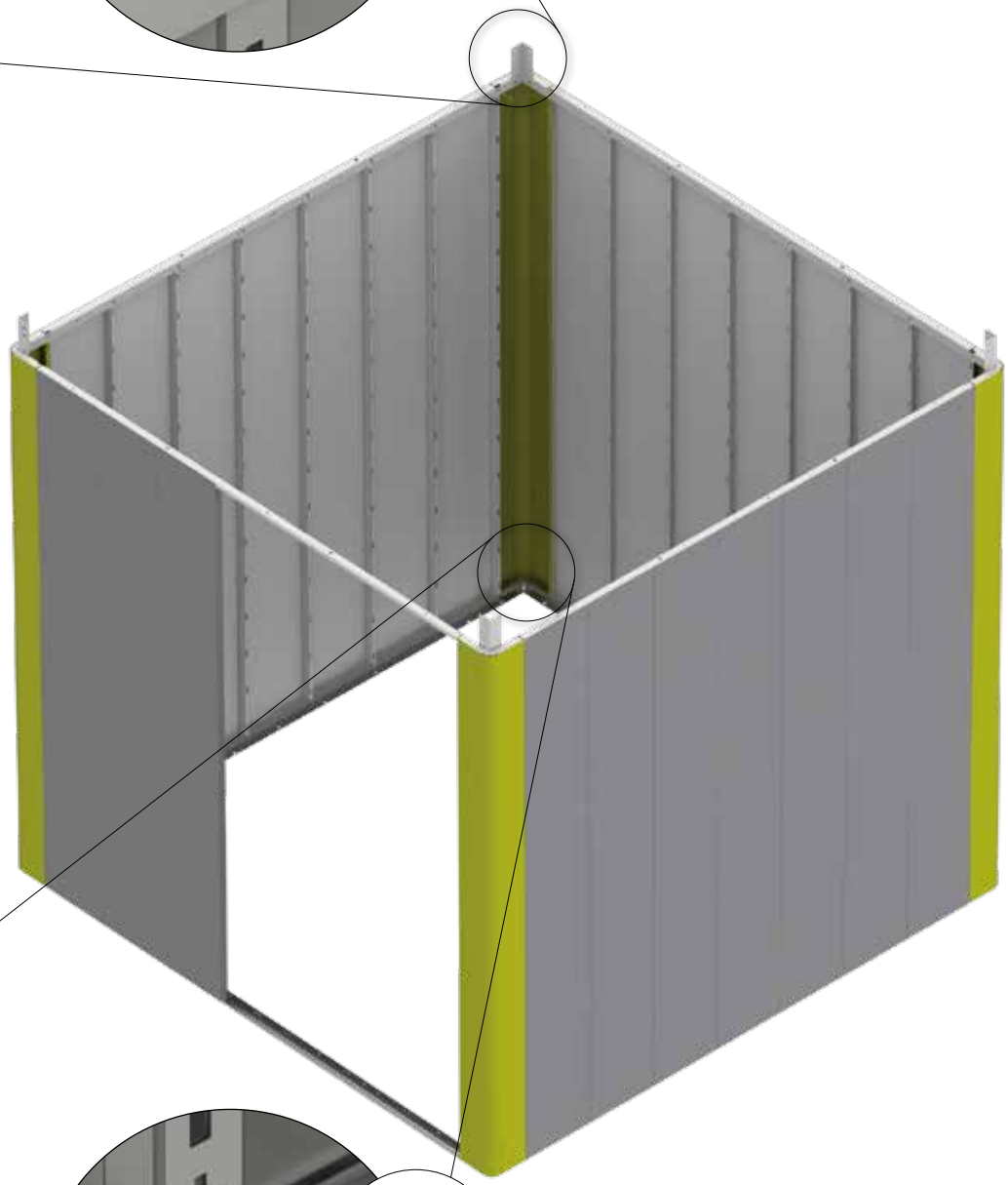
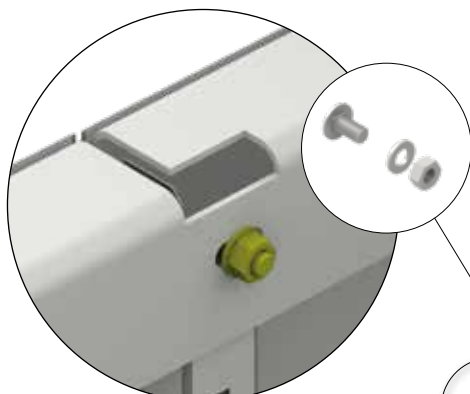
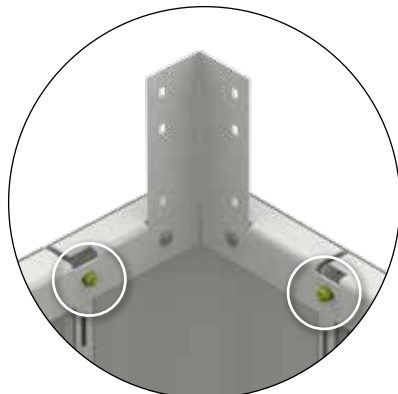

- 1A: 16x
- 2A: 16x
- 1B: 16x
- 2B: 16x



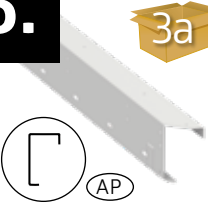

# 16.

 3a AP	1A: 1X (1717 mm) 2A: 1X (1717 mm) 1B: 1X (2277 mm) 2B: 1X (2277 mm)	 3a AU	1A: 1X (1619 mm) 2A: 1X (1619 mm) 1B: 1X (2179 mm) 2B: 1X (2179 mm)	M5 x 10 D1	 7	1A: 9x 2A: 9x 1B: 11x 2B: 11x
--	--	--	--	---------------	---	--

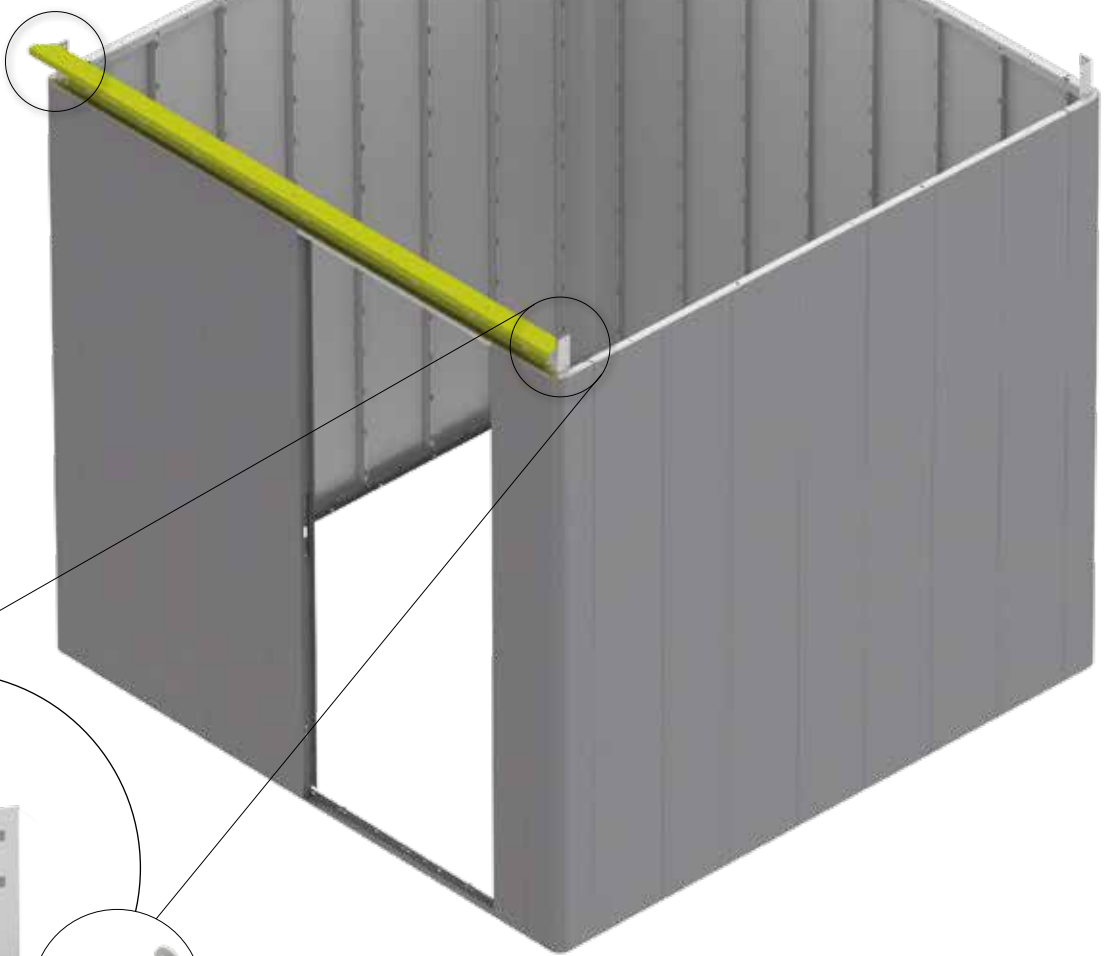
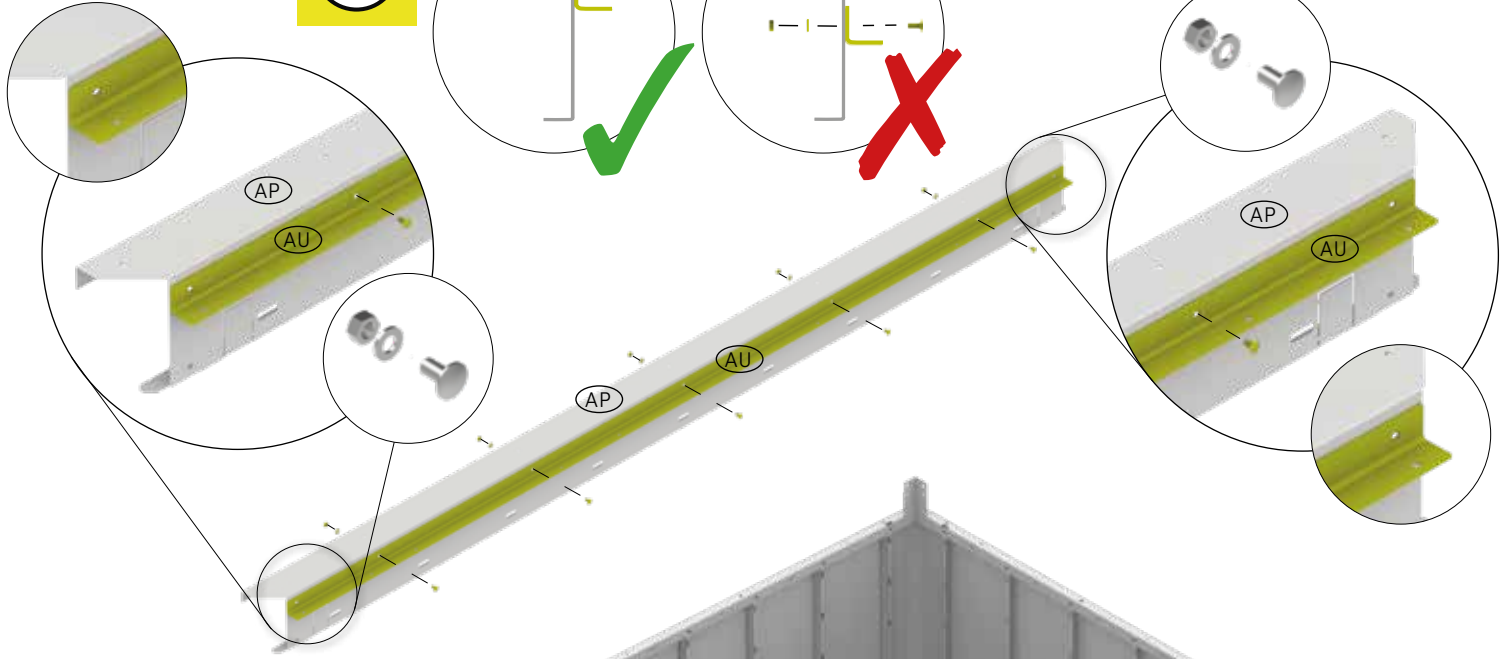
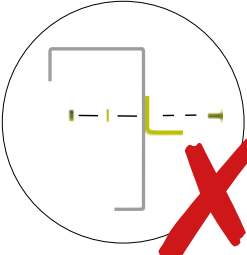
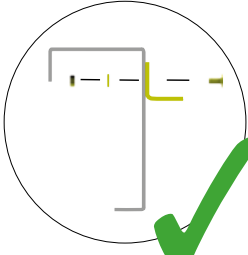

# 17.



**3a**

1A:	1X (1717 mm)
2A:	1X (1717 mm)
1B:	1X (2277 mm)
2B:	1X (2277 mm)

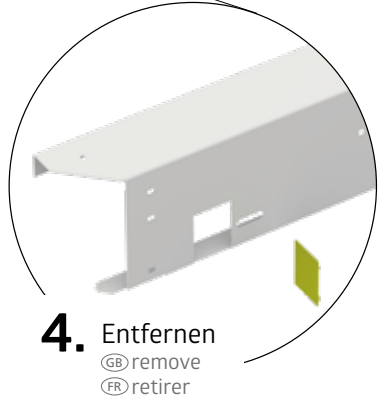
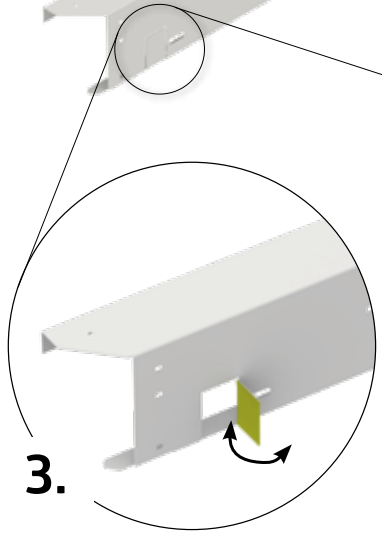
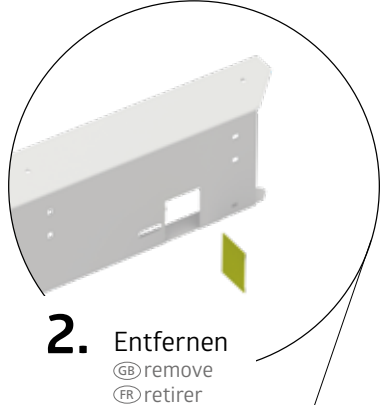
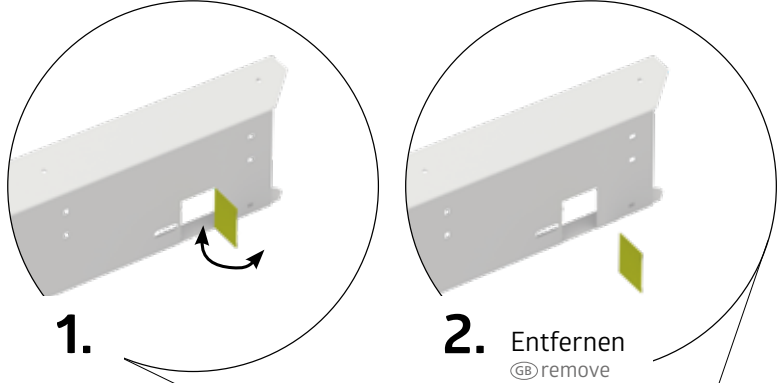







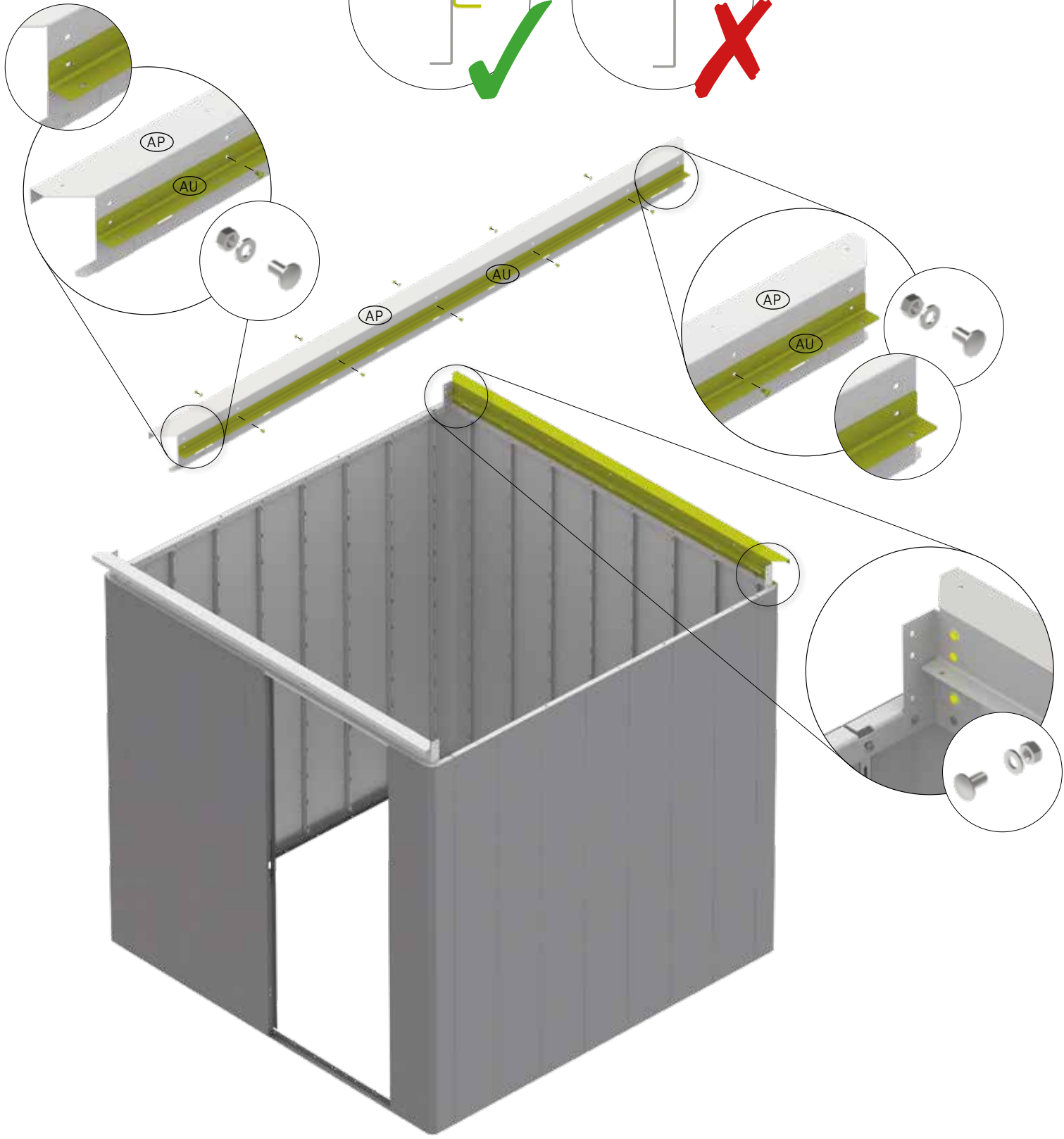
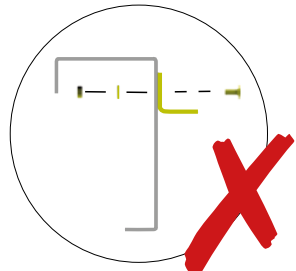
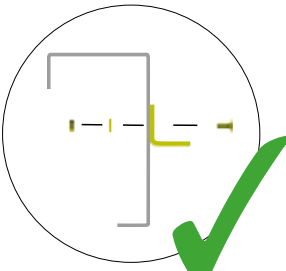

# 18.

 (AU)	3a	1A: 1X (1619 mm)	 M5x10 (D1)	7	1A: 9X
		2A: 1X (1619 mm)		2A: 9X	
		1B: 1X (2179mm)		1B: 11X	
		2B: 1X (2179 mm)		2B: 11X	



# 19.

 BP	 1A: 1X (1717 mm)	 BU	 1A: 1X (1553 mm)	 M5 x 10	 D1	 1A: 9X
	2A: 1X (2277 mm)		2A: 1X (2113 mm)		2A: 11X	
	1B: 1X (1717 mm)		1B: 1X (1553 mm)		1B: 9X	
	2B: 1X (2277 mm)		2B: 1X (2113 mm)		2B: 11X	





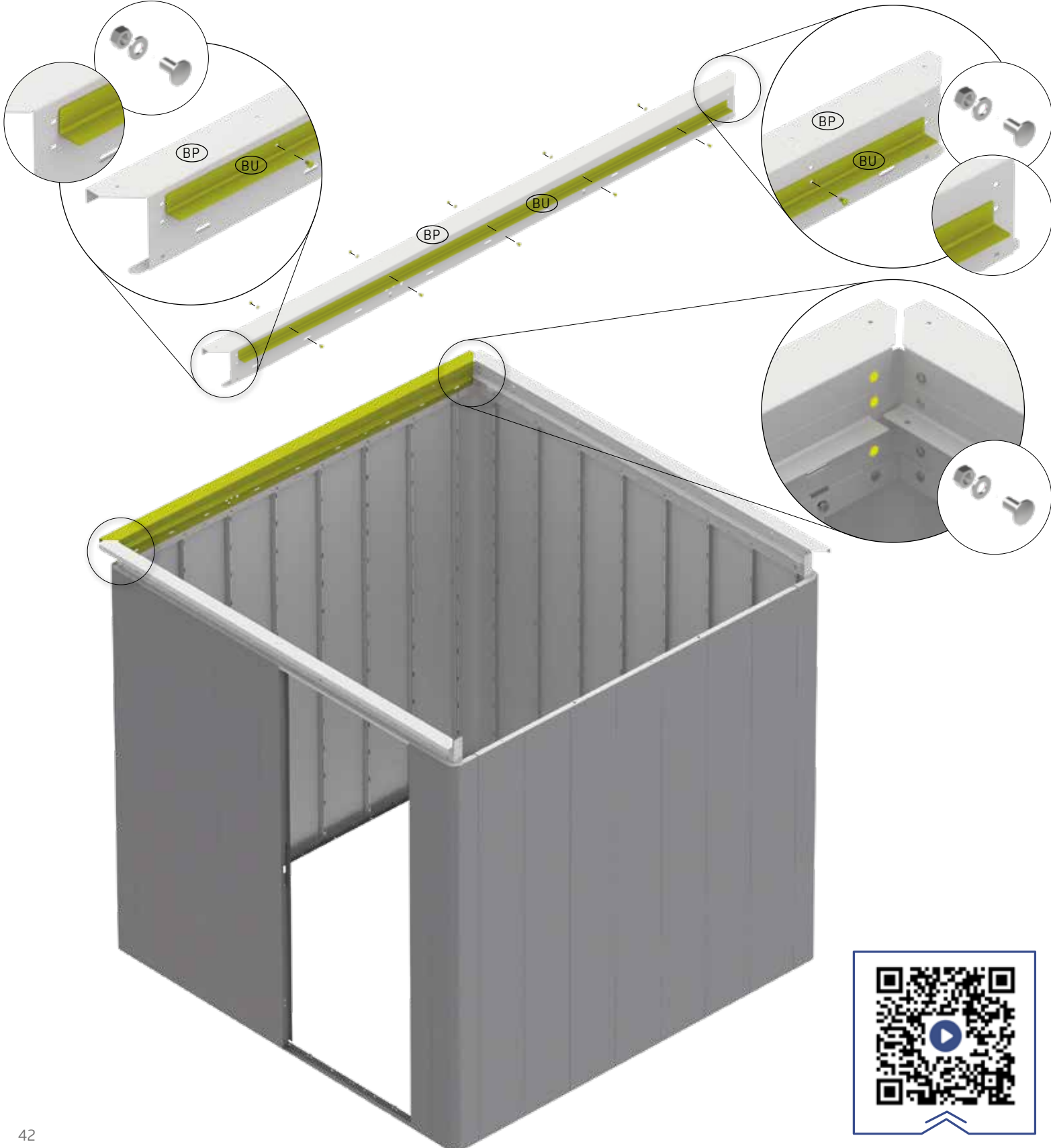
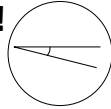

## Achten Sie auf das Gefälle!

GB Pay attention to the slope!

FR Attention aux pentes!

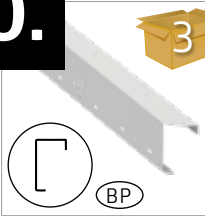

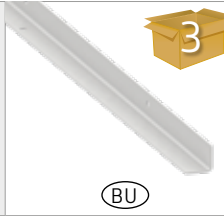
# 20.

 BP	 1A: 1X (1717 mm) 2A: 1X (2277 mm) 1B: 1X (1717 mm) 2B: 1X (2277 mm)	 BU	 1A: 1X (1553 mm) 2A: 1X (2113 mm) 1B: 1X (1553 mm) 2B: 1X (2113 mm)	M5 x 10	 D1	1A: 9X 2A: 11X 1B: 9X 2B: 11X
---	--	--	--	---------	--	--



## Achten Sie auf das Gefälle!

GB Pay attention to the slope!

FR Attention aux pentes!

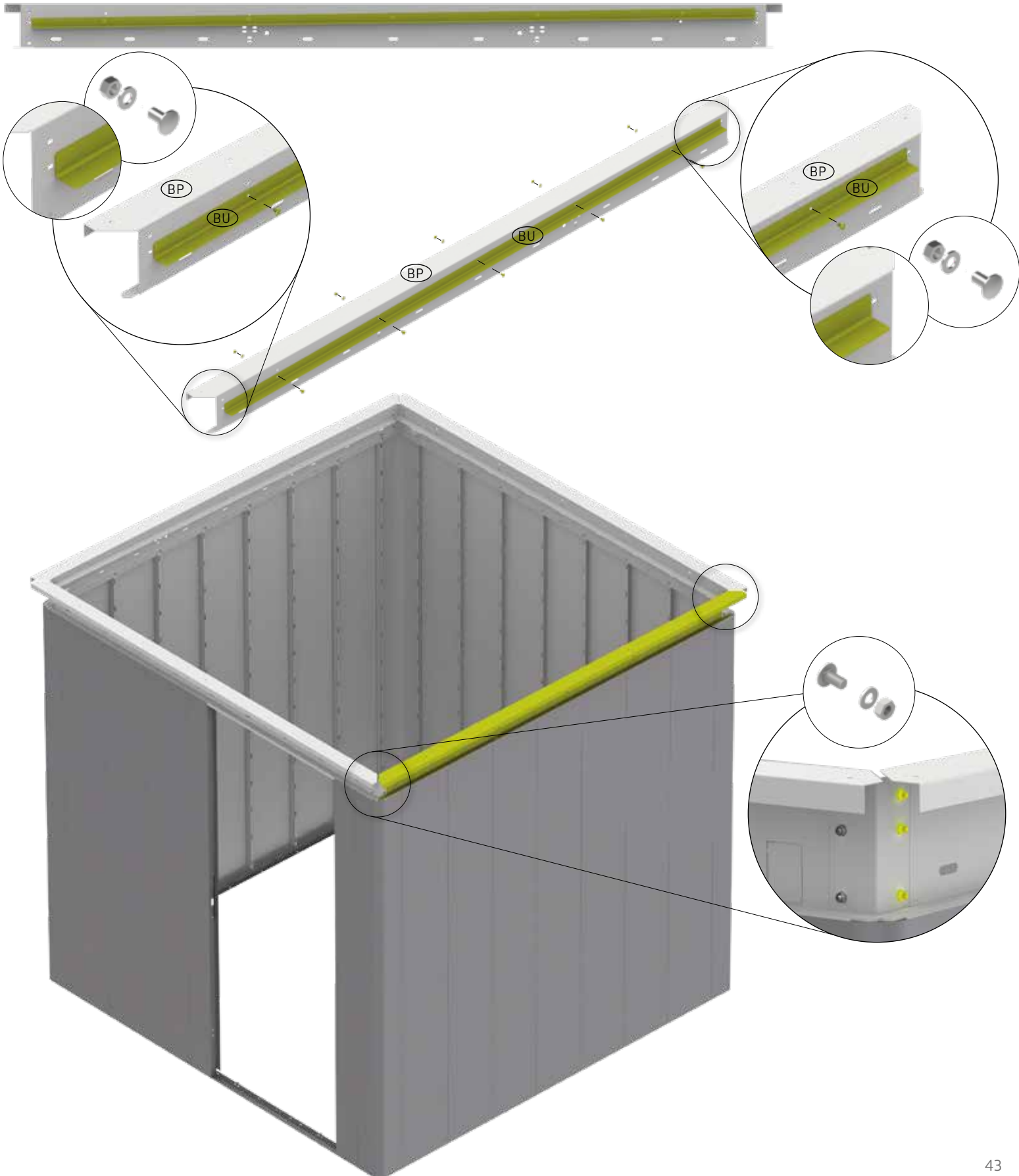
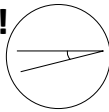



# 21.

3a

- 1A: 2X (1690 mm)
- 2A: 2X (1690 mm)
- 1B: 2X (2250 mm)
- 2B: 2X (2250 mm)

7



D1

- 1A: 12X
- 2A: 12X
- 1B: 12X
- 2B: 12X

Ⓢ

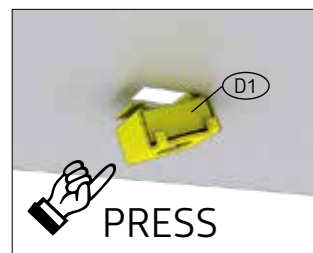
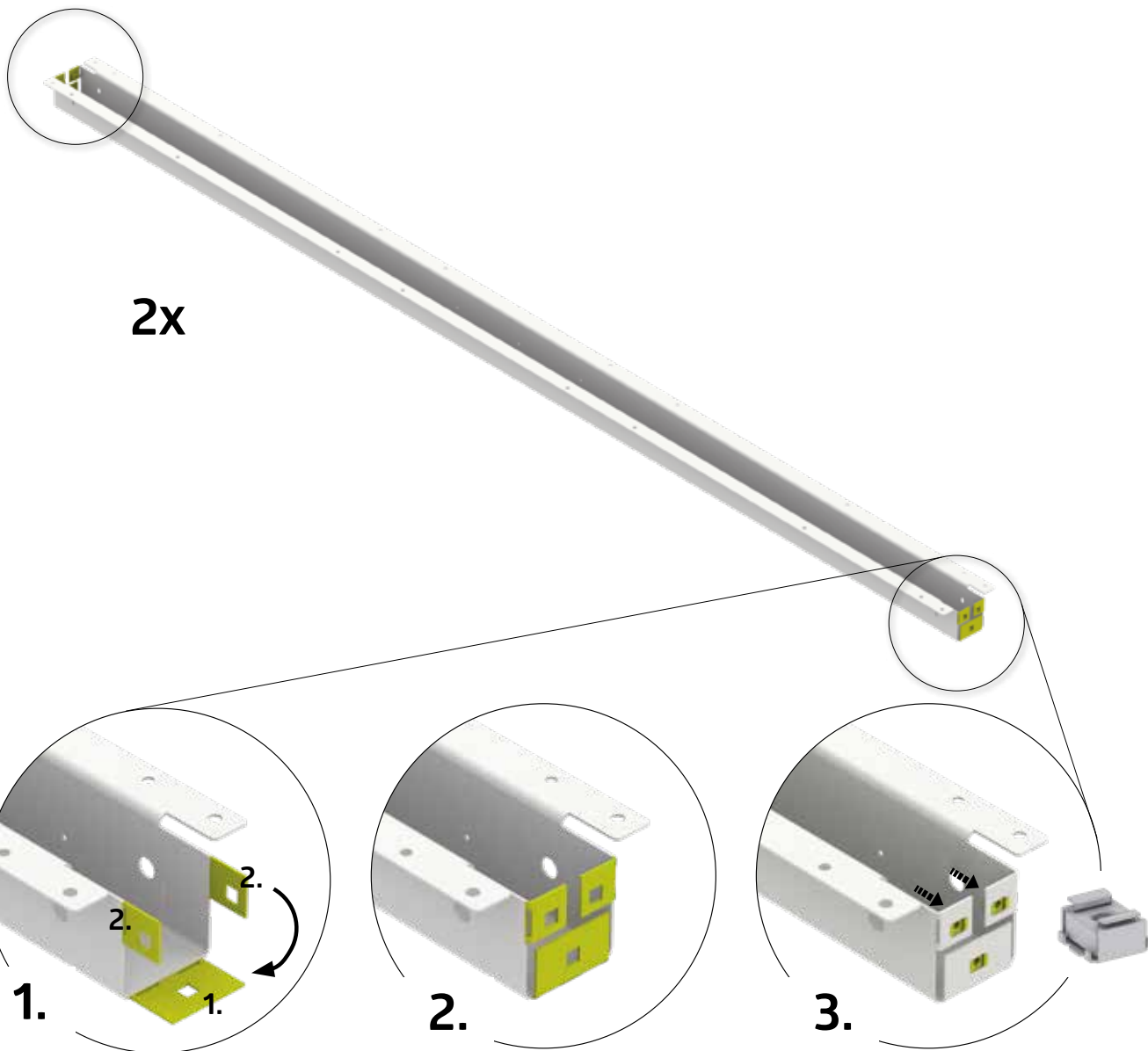

# 22.



7

1A: 12x

2A: 12x

1B: 12x

2B: 12x

M5 x 16



D1

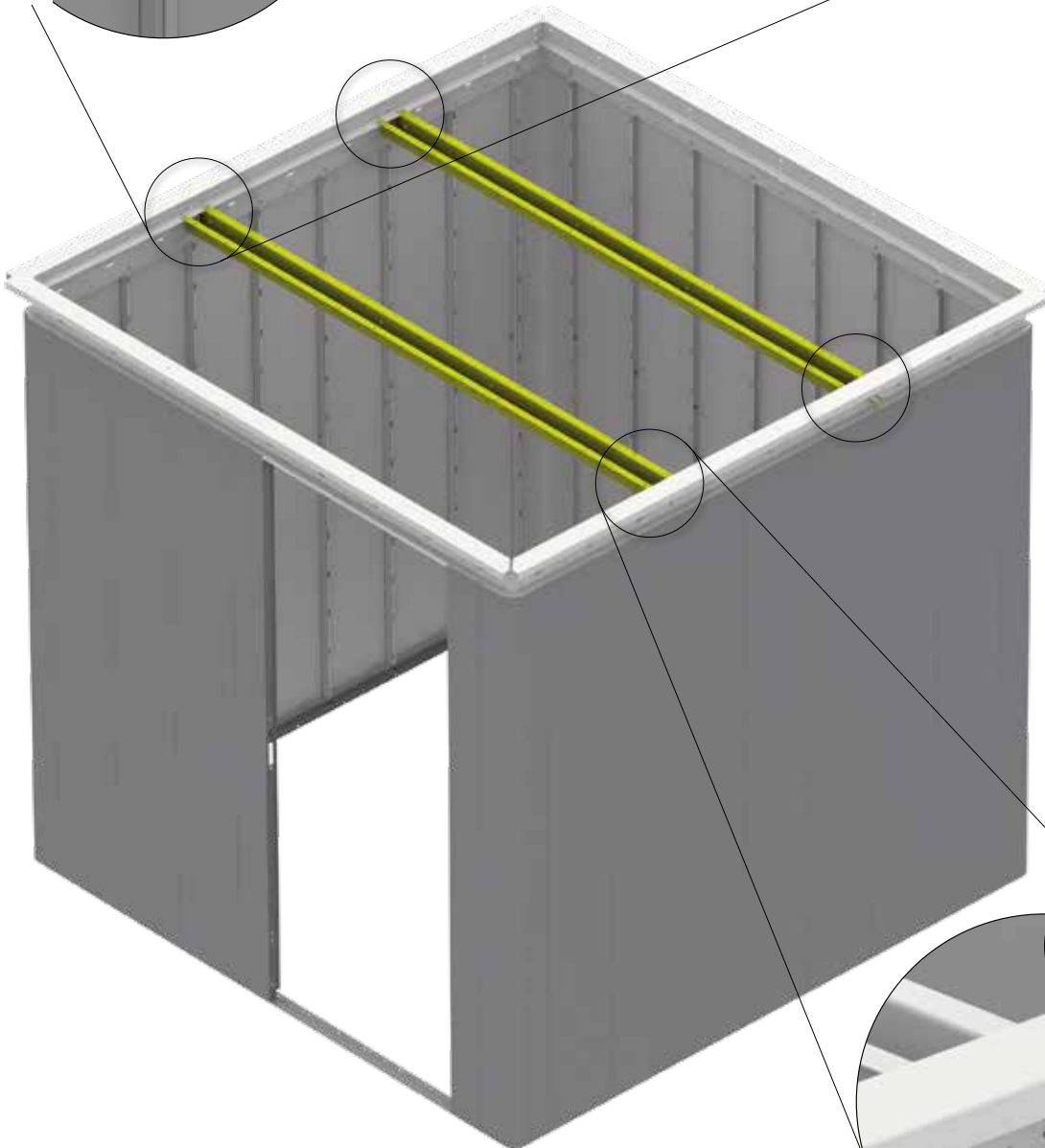
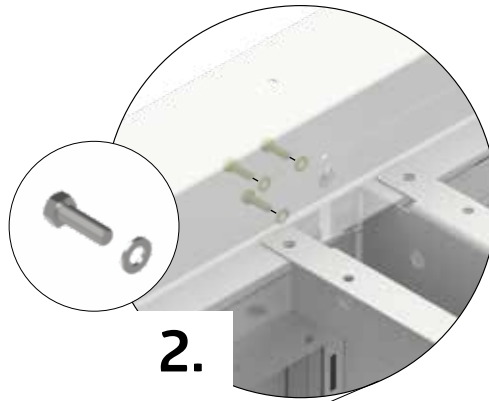
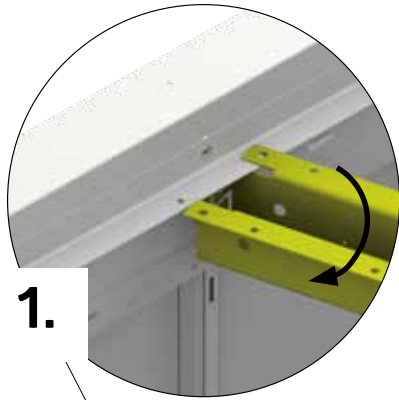

# 23.

 <p>(RA)</p>	<p>7</p> <p>1A: 2X 2A: 2X 1B: 2X 2B: 2X</p>	<p>4,8 x 13</p>  <p>(D2)</p>	<p>7</p> <p>1A: 6X 2A: 6X 1B: 6X 2B: 6X</p>	 <p>(W)</p>	<p>4</p> <p>1A: 1X (1624 mm) 2A: 1X (2184 mm) 1B: 1X (1624 mm) 2B: 1X (2184 mm)</p>
 <p>(Y)</p>	<p>4</p> <p>1A: 1X (1624 mm) 2A: 1X (2184 mm) 1B: 1X (1624 mm) 2B: 1X (2184 mm)</p>	<p>7</p>  <p>(D2)</p>	<p>7</p> <p>1A: 2X 2A: 2X 1B: 2X 2B: 2X</p>		

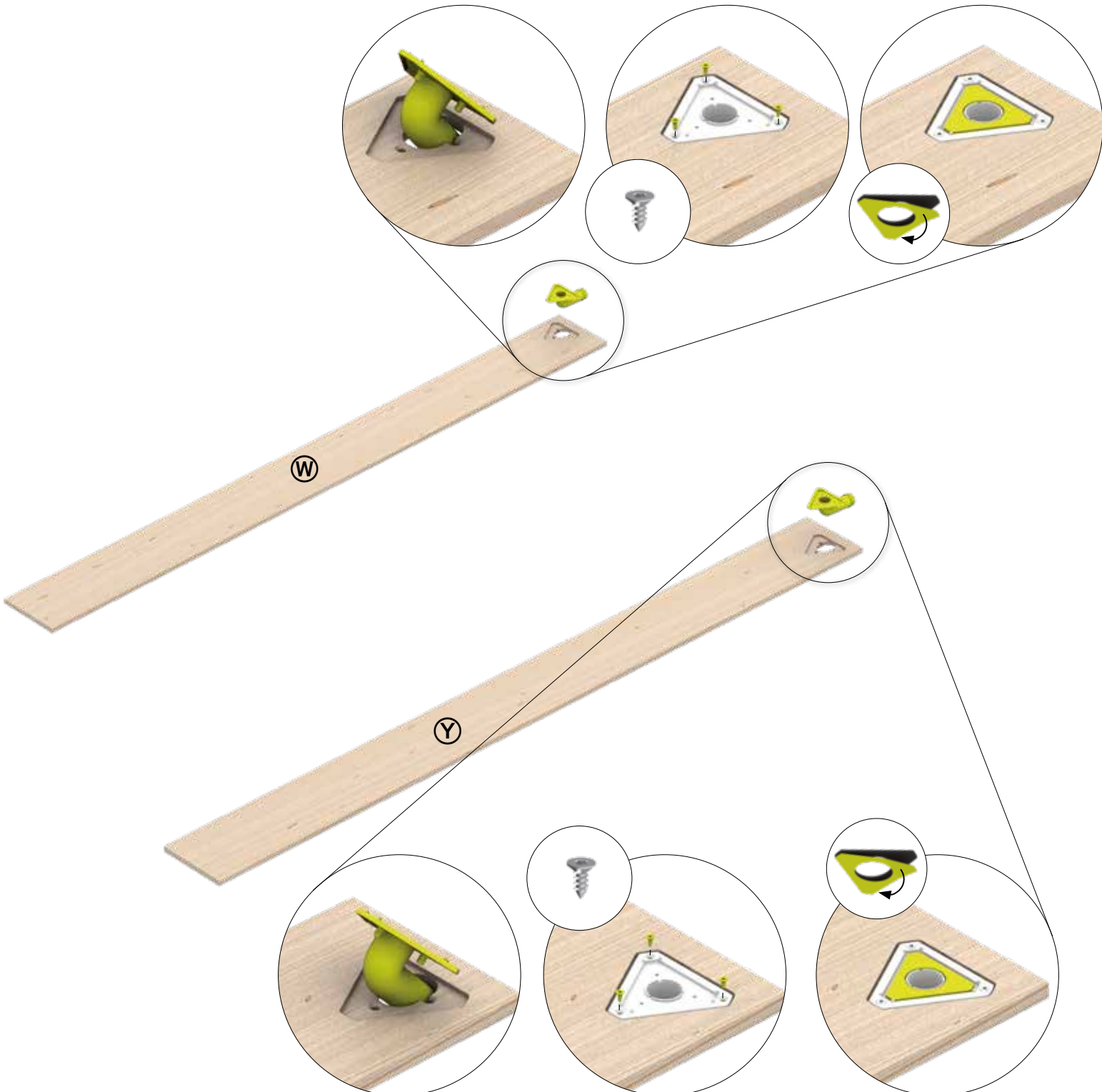

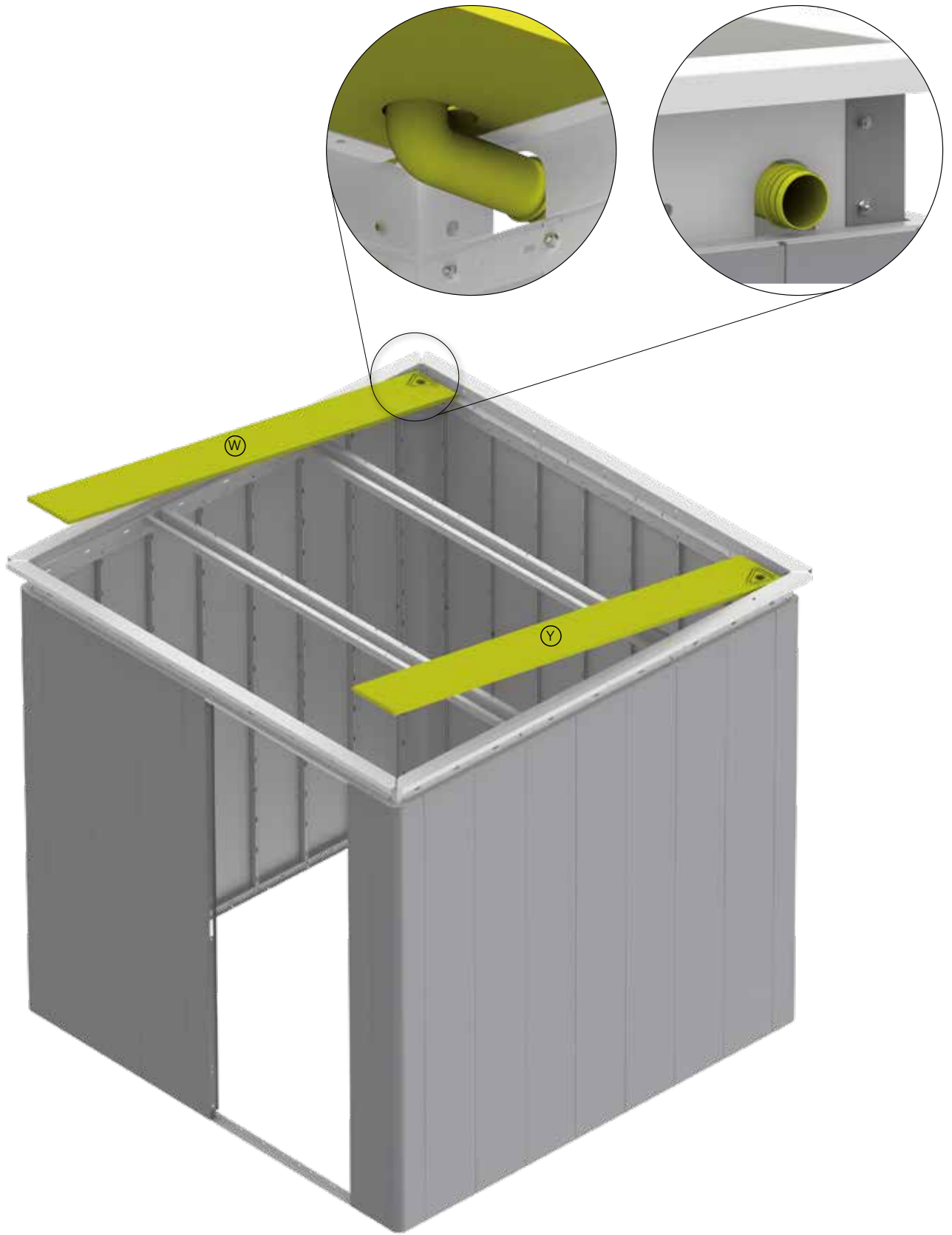

25.

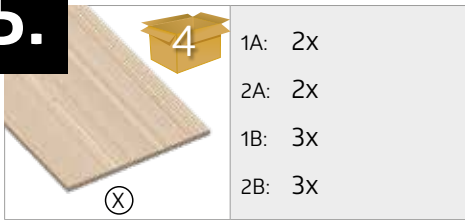

4

1A:	2x
2A:	2x
1B:	3x
2B:	3x

⊗

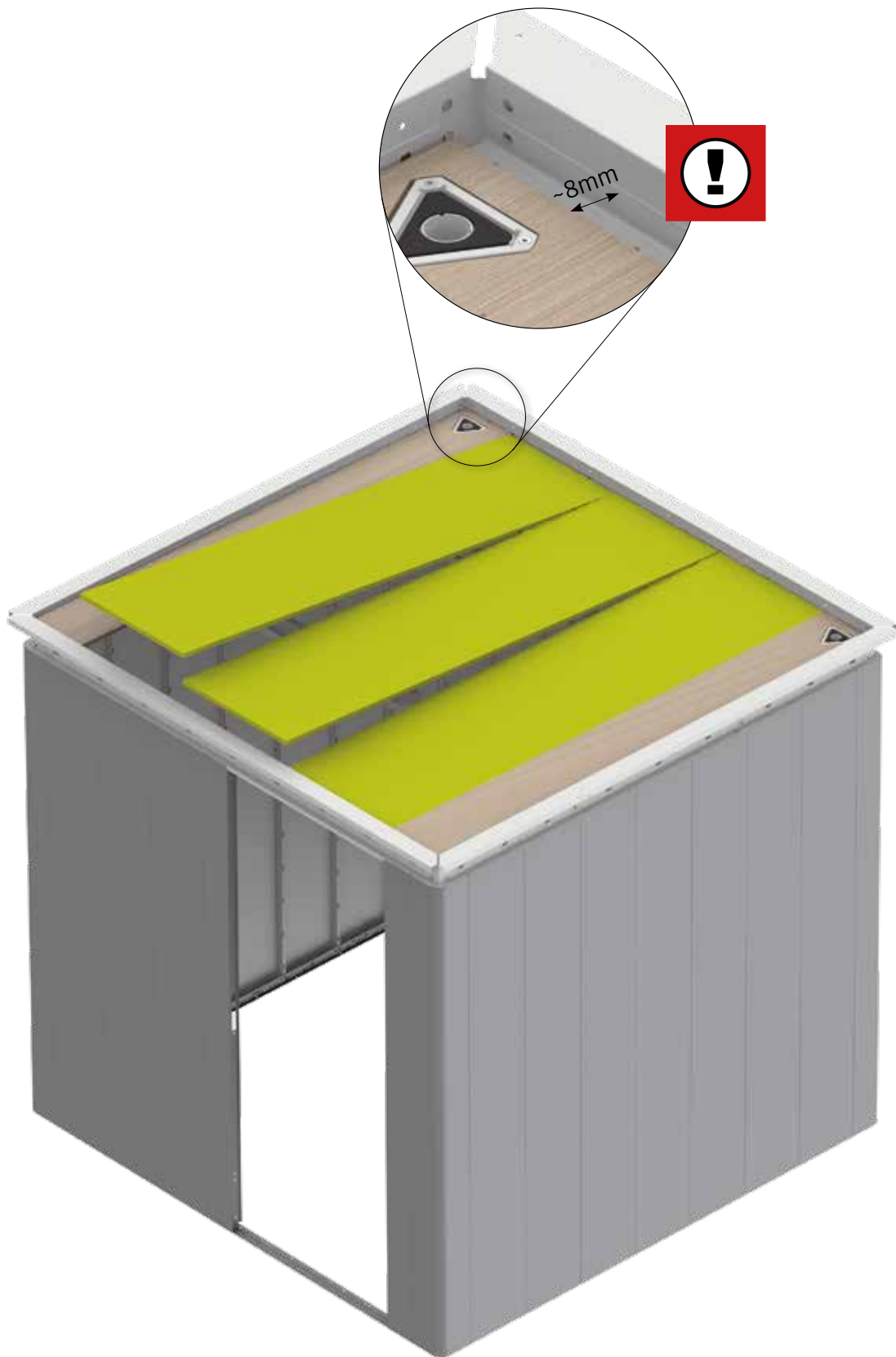



# 26.

## Rechtwinkelig einrichten

- Ⓒ square the base
- Ⓔ ajuster en forme rectangulaire
- Ⓓ rechthoekig instellen
- Ⓔ ajustar en forma rectangular
- Ⓓ mettere in forma rettangolare
- Ⓒ indstil vinkelret

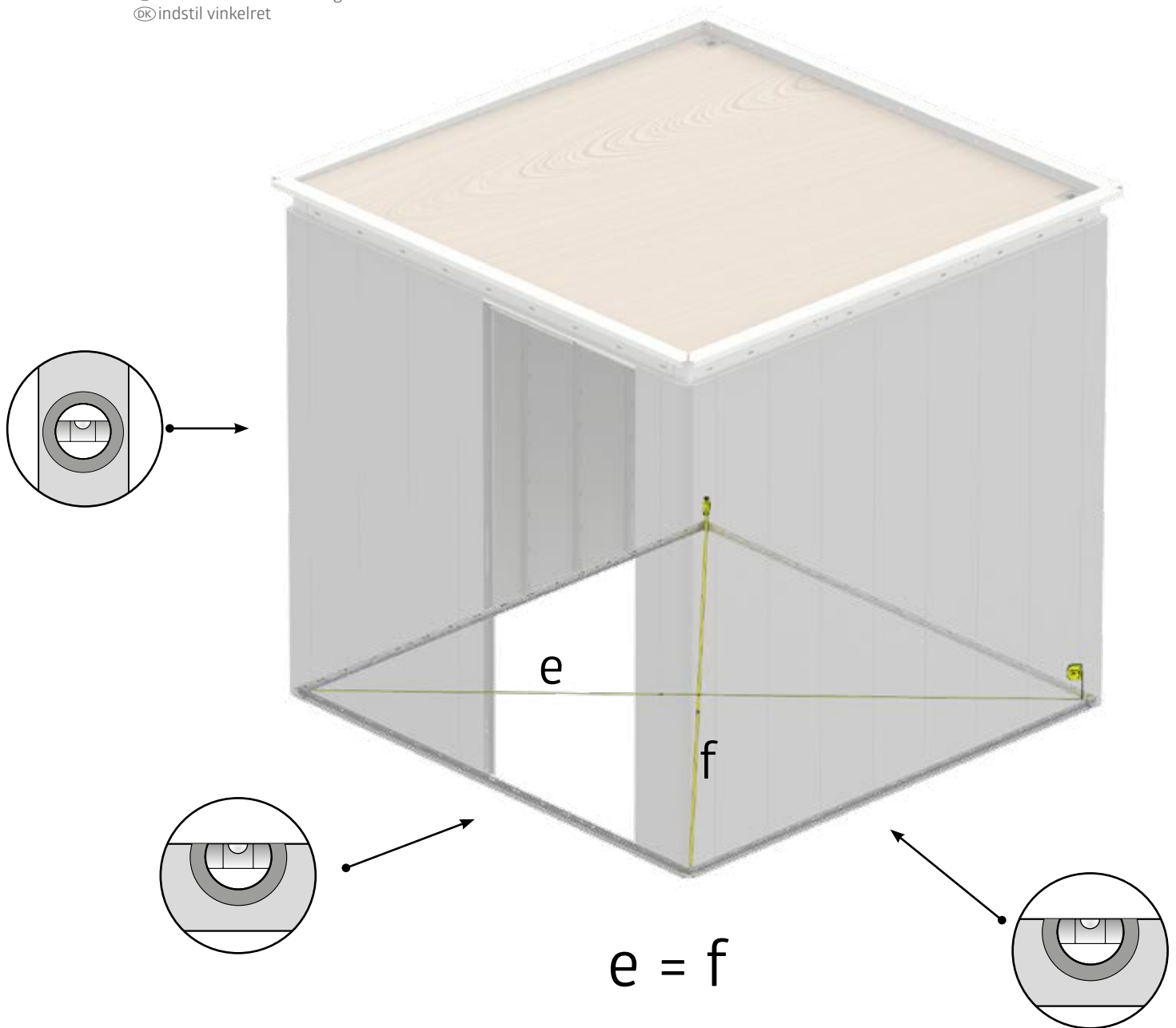

**!** **Ziehen Sie jetzt alle Schraubverbindungen fest an!**  
Tighten now all nuts and connections securely! - Serrez maintenant les vis à fond! - Draai nu alle schroeven vast! - Ahora puede apretar y fijar todos los tornillos y tuercas - Adesso serrare a fondo tutti i dadi - Fastspænd nu alle bolt-/skruerforbindelser!

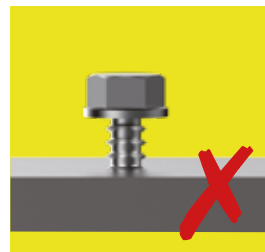
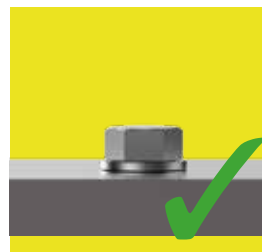

# 27.

5 x 20



- 1A: 32x
- 2A: 32x
- 1B: 48x
- 2B: 48x

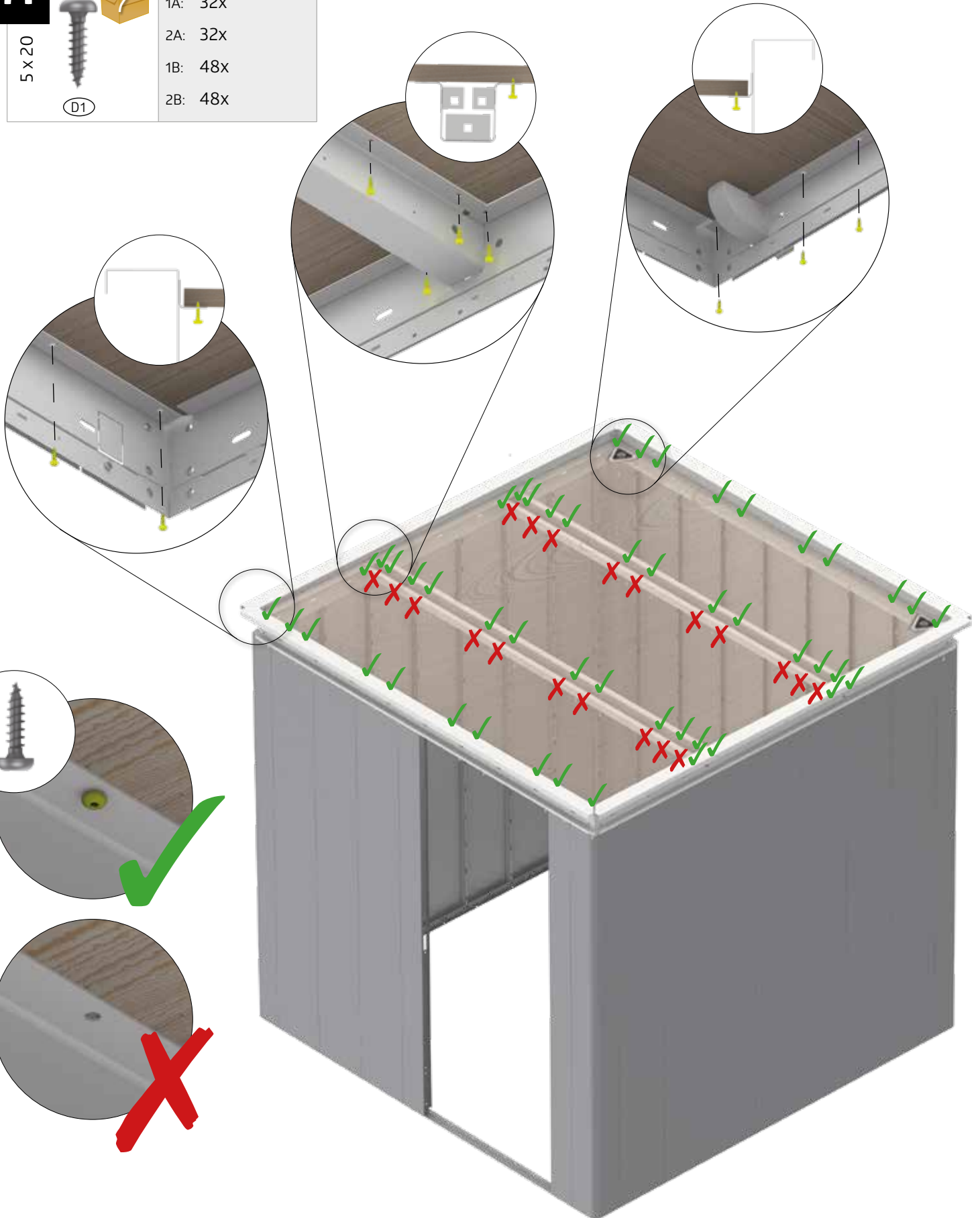

## Ziehen Sie jetzt alle Schraubverbindungen fest an!

Tighten now all nuts and connections securely! - Serrez maintenant les vis à fond! - Draai nu alle schroeven vast! - Ahora puede apretar y fijar todos los tornillos y tuercas - Adesso serrare a fondo tutti i dadi - Fastspænd nu alle bolt-/skruerforbindelser!

28.



1A: 1X (880 mm)

2A: 1X (880 mm)

1B: 1X (880 mm)

2B: 1X (880 mm)

ⓐ

### OPTION Doppeltür

Double door - Deuxième battant de porte -  
Tweede deurvleugel - Secondo battente -  
puerta doble - Dobbeltjør



1B: 1X (1720 mm)

2B: 1X (1720 mm)

ⓐ

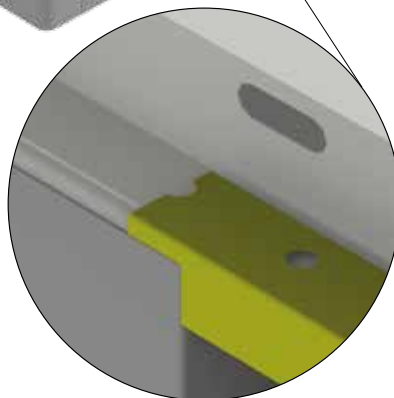
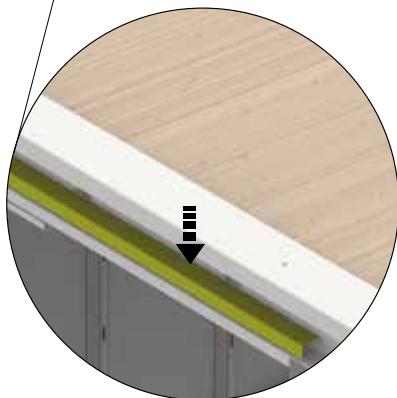

# 29.

M5 x 18  
D1

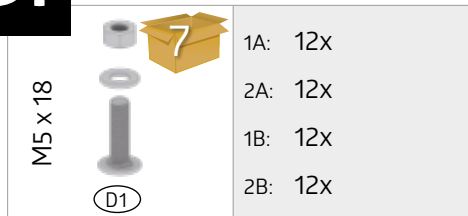





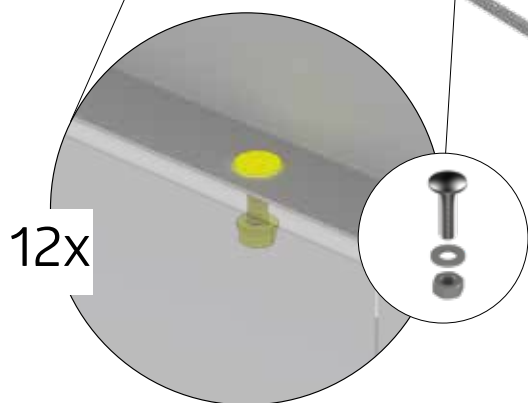
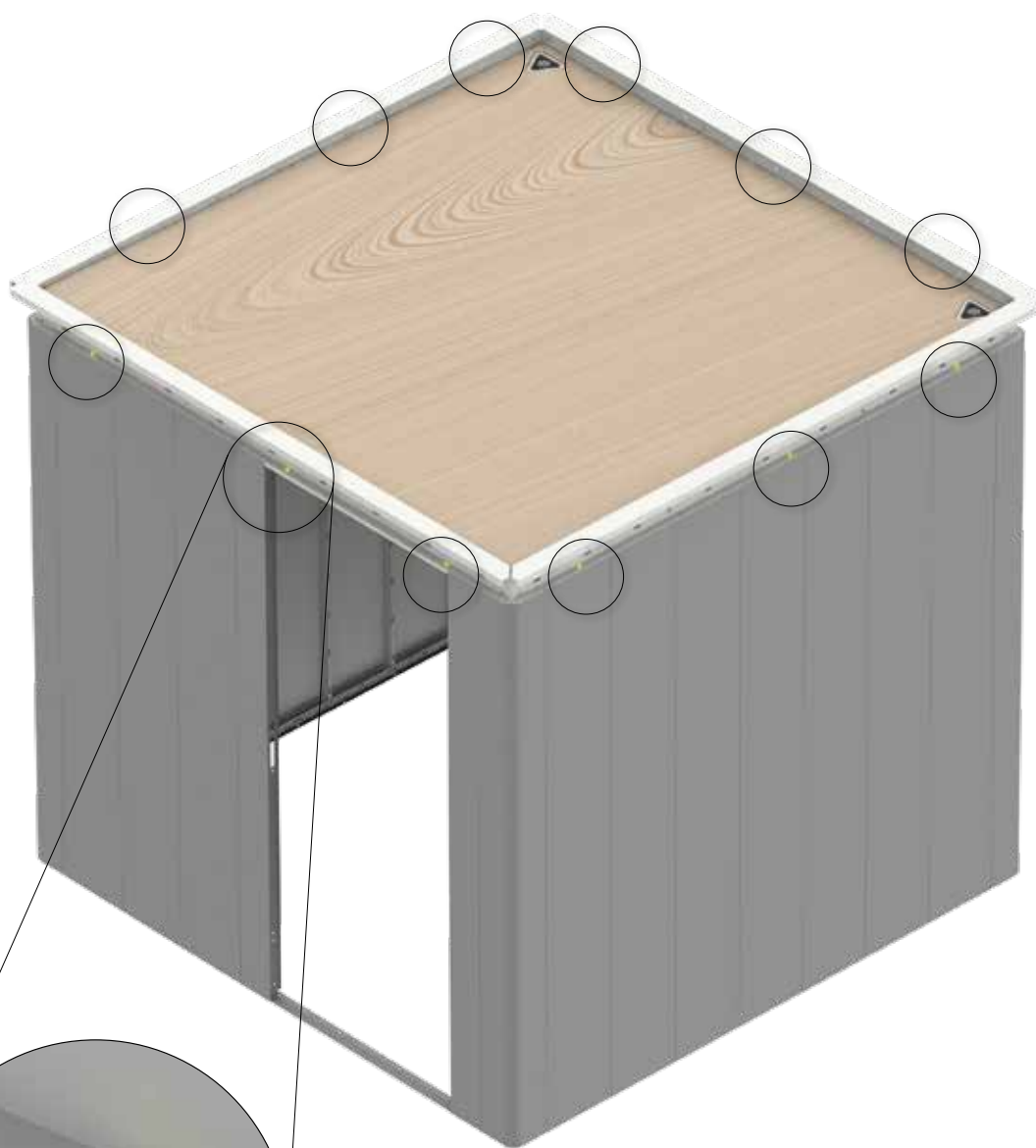
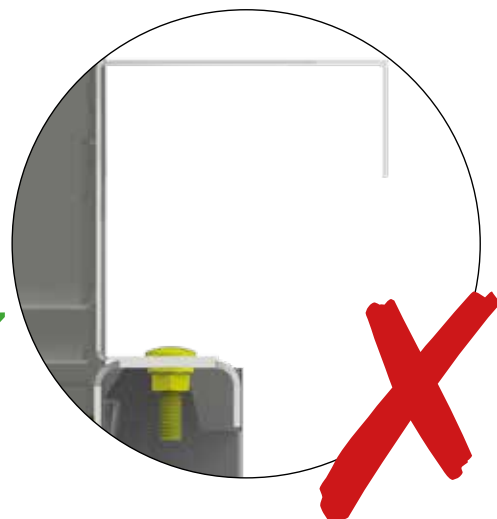





1A: 12x  
2A: 12x  
1B: 12x  
2B: 12x

A parts list box containing a small yellow box with the number '7' inside, and a list of parts: 1A: 12x, 2A: 12x, 1B: 12x, and 2B: 12x. To the left of the list is a vertical label 'M5 x 18' and a circled 'D1'.



# 30.

 <p>Ⓟ</p>	 <p>1A: 2x 2A: 2x 1B: 2x 2B: 2x</p>	 <p>Ⓜ</p>	 <p>1A: 2x 2A: 2x 1B: 2x 2B: 2x</p>	<p>4,8 x 13</p>  <p>Ⓧ</p>	 <p>1A: 4x 2A: 4x 1B: 4x 2B: 4x</p>
 <p>Ⓧ</p>	 <p>1A: 2x 2A: 2x 1B: 2x 2B: 2x</p>	 <p>Ⓜ</p>	 <p>1A: 2x 2A: 2x 1B: 2x 2B: 2x</p>		

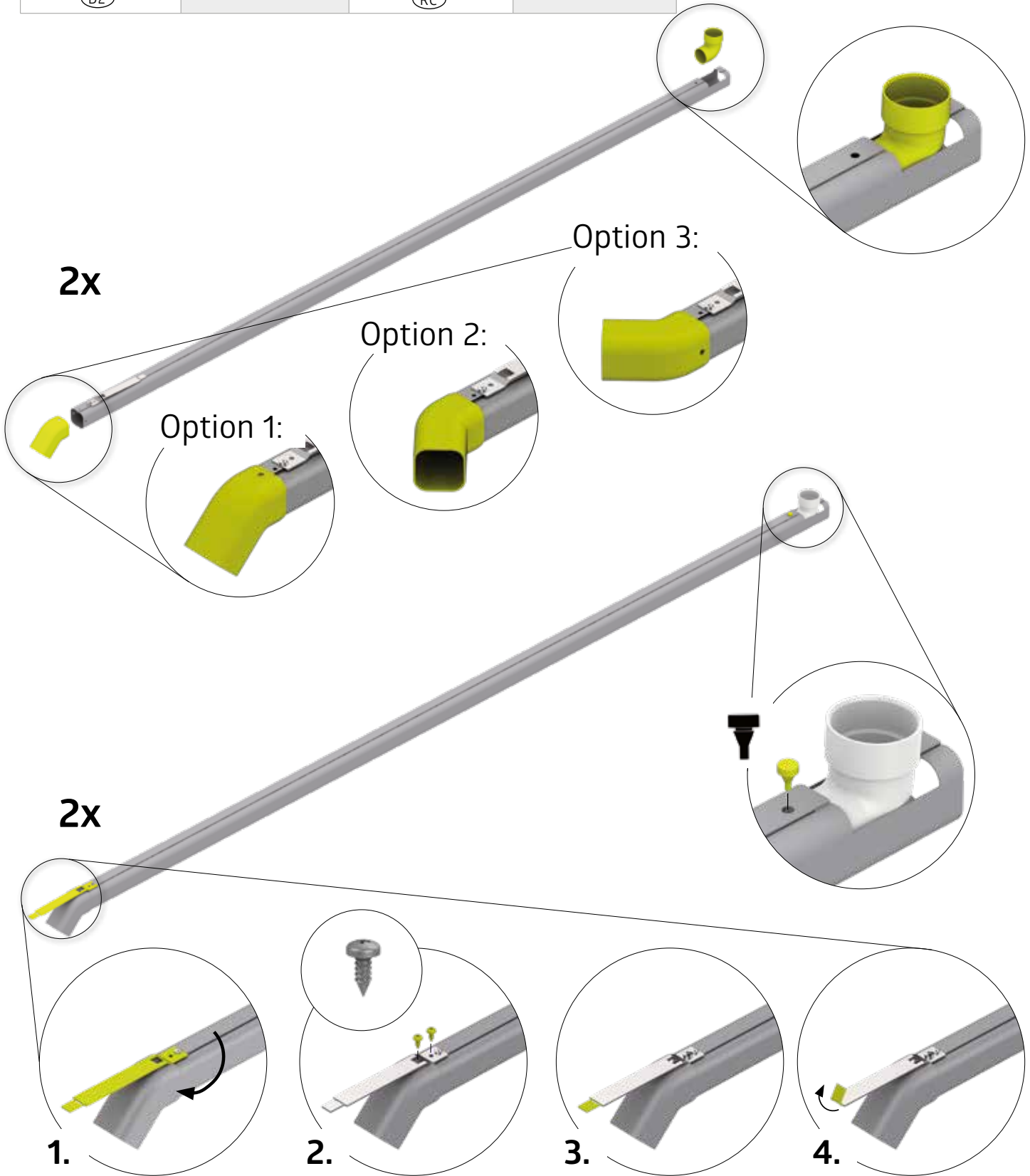



# 31.

## Ansicht Rückseite

Back side view - Vue arrière - Rugaanzicht - Vista trasera - Vista posteriore - Se bagside

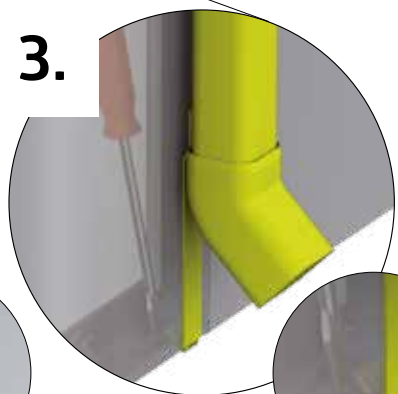
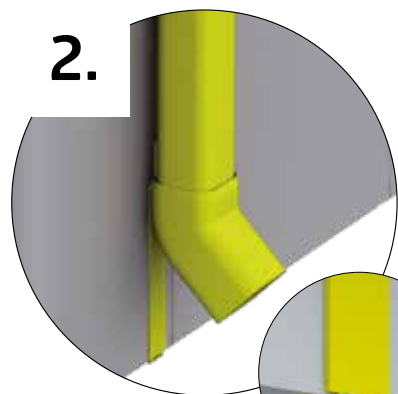
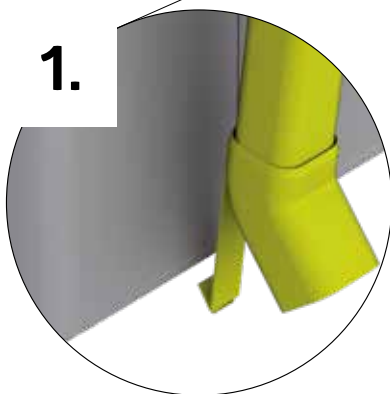
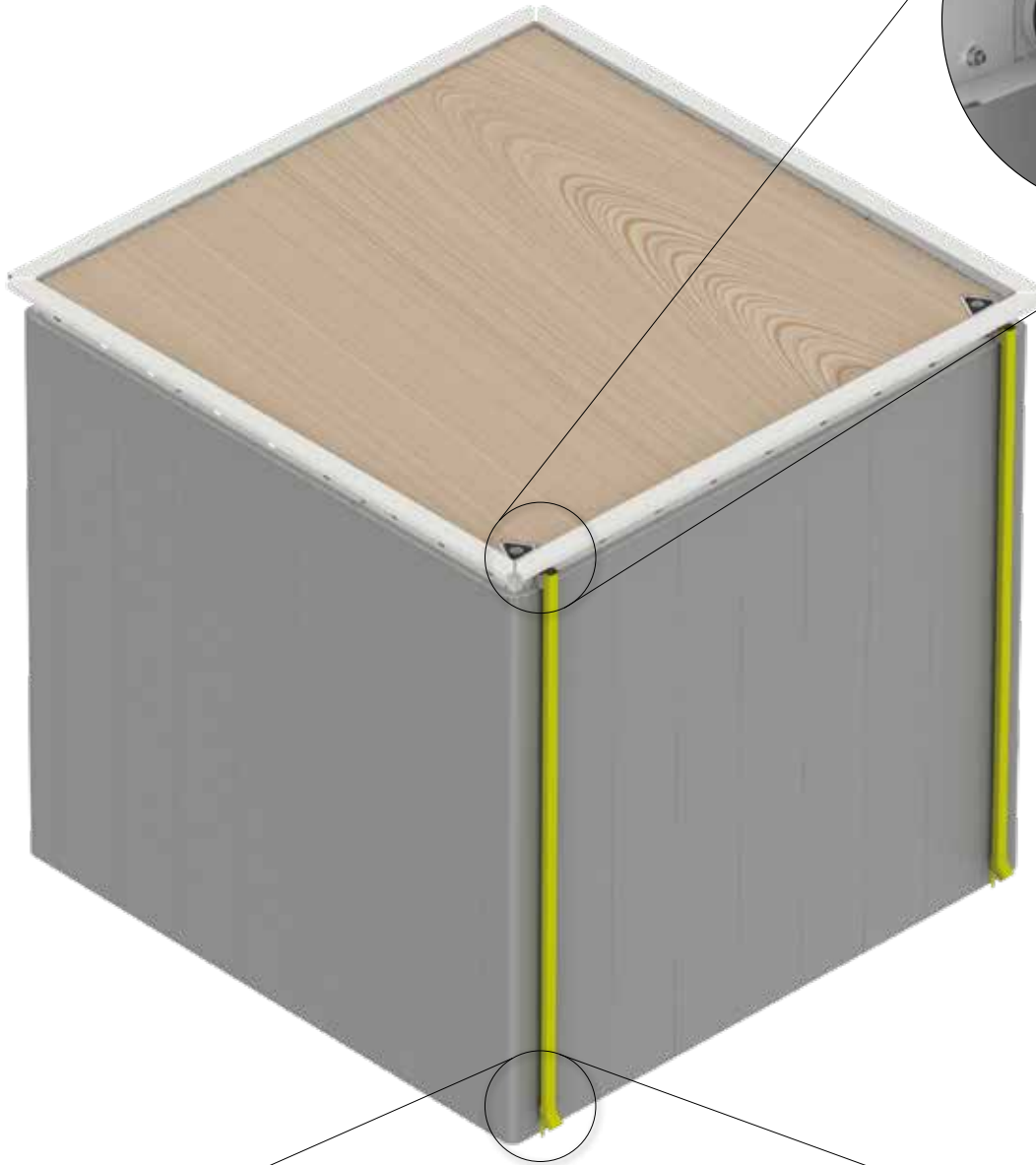

# 32.

6



- 1A: 1X (1910x1910 mm)
- 2A: 1X (2470x1910 mm)
- 1B: 1X (2470x1910 mm)
- 2B: 1X (2470x2470 mm)

## Mögliche Schweißnaht der Folie darf nicht im Gullybereich sein.

Ⓒ Possible welding seam of the membrane must not be in the gully area.

Ⓕ Le point de collage éventuel du film ne doit pas se trouver dans la zone de l'évacuation d'eaux.

Ⓓ Mogelijk laspunt van de folie mag niet in de buurt van de afloop liggen.

Ⓔ El posible punto de soldadura de la lámina no debe estar en la zona del desagüe.

Ⓗ L'eventuale punto di giunzione della pellicola non deve trovarsi nell'area della bocchetta di scarico acque.

Ⓖ Det mulige svejsepunkt på folien må ikke være i kløften.



# 33.



## Ansicht Rückseite

Back side view - Vue arrière - Rugaanzicht - Vista trasera - Vista posteriore - Se bagside

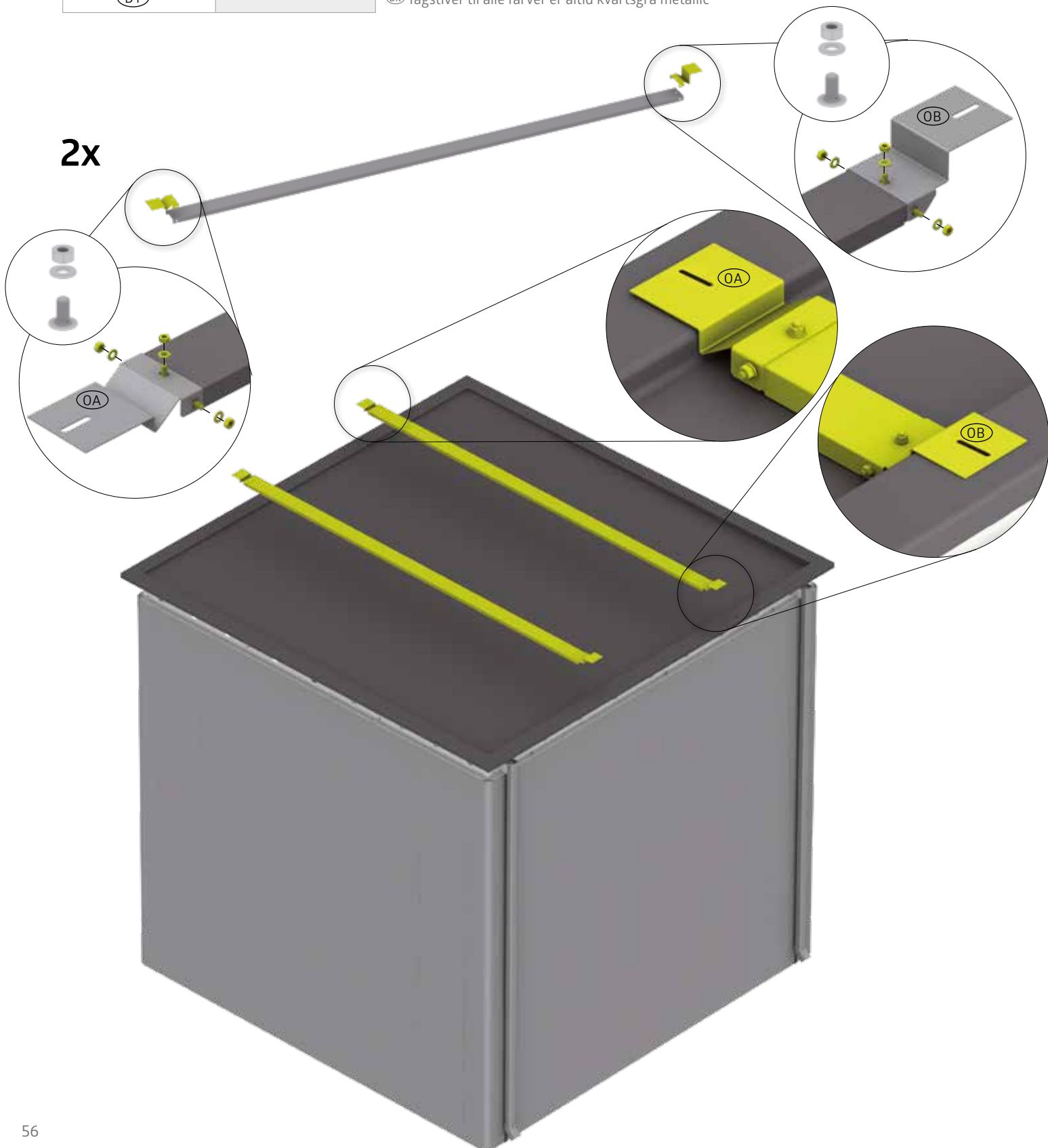
 	 1A: 2X (1573 mm) 2A: 2X (2133 mm) 1B: 2X (1573 mm) 2B: 2X (2133 mm)	  1A: 2X 2A: 2X 1B: 2X 2B: 2X	  1A: 2X 2A: 2X 1B: 2X 2B: 2X
	<p><b>ACHTUNG! Dachstrebe für alle Farben immer quarzgrau</b></p> <p>             Ⓒ CAUTION! Roof strut for all colours always quartz grey.              Ⓓ ATTENTION : La traverse du toit pour toutes les couleurs d'abris est gris quartz.              Ⓔ OPGELET: de daksteunen zijn altijd kwartsgrijs (ongeacht de kleur van de berging).              Ⓕ ATENCIÓN: El puntal del techo para todos los colores siempre es gris cuarzo.              Ⓗ ATTENZIONE: montante del tetto per tutti i colori sempre grigio quarzo.              Ⓖ Tagstiver til alle farver er altid kvartsgrå metallic           </p>		

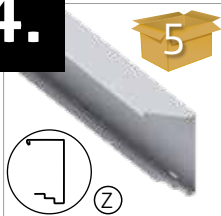

# 34.

 5	1A: 3X (1737 mm) 2A: 1X (1737 mm) 2X (2297 mm) 1B: 1X (2297 mm) 2X (1737 mm) 2B: 3X (2297 mm)	 7	1A: 2X 2A: 2X 1B: 2X 2B: 2X
--	--	---	--------------------------------------



1.

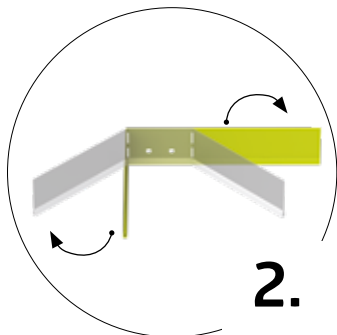

2.

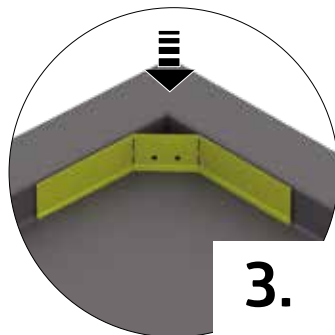

3.



4.



### Folie andrücken!

- GB Push down on the membrane!
- FR Presser le film!
- NL Folie aandrukken
- ES Presione sobre el papel de aluminio
- IT Premere il telo
- DK Tryk folien på!

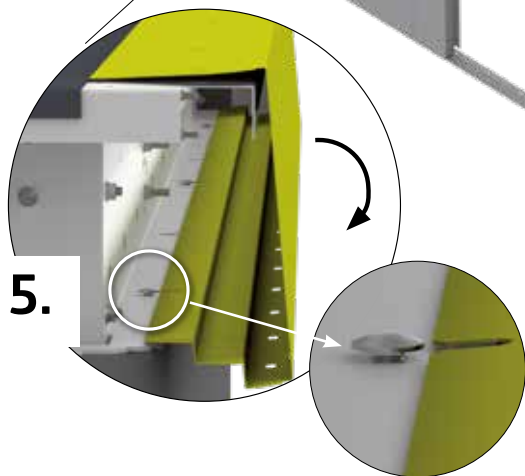

5.

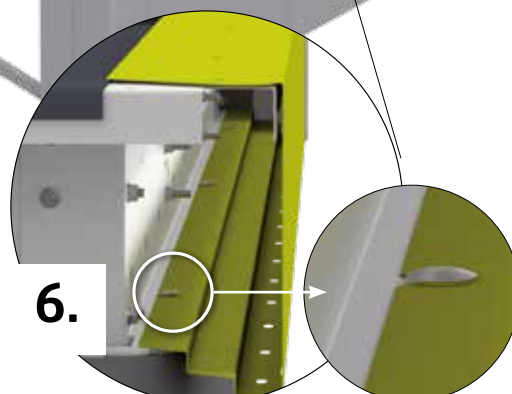

6.

# 35.

## Ansicht Rückseite

Back side view - Vue arrière - Rugaanzicht - Vista trasera - Vista posteriore - Se bagside

5

1A: 1X (1737 mm)

2A: 1X (1737 mm)

1B: 1X (2297 mm)

2B: 1X (2297 mm)

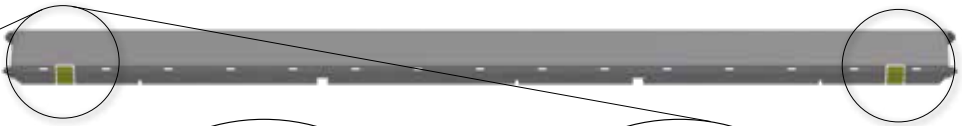

**Folie andrücken!**

GB Push down the membrane!

FR Presser le film!

NL Folie aandrukken

ES Presione sobre el papel de aluminio

IT Premere il telo

DK Tryk folien på!

1.

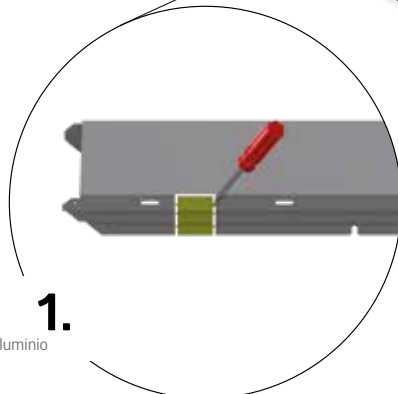

2.

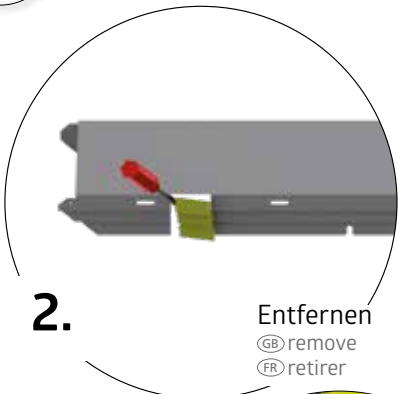

Entfernen

GB remove

FR retirer

3.

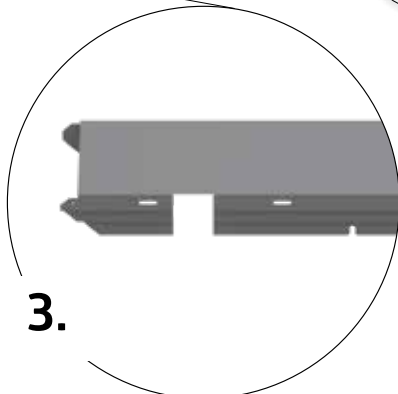

5.



4.

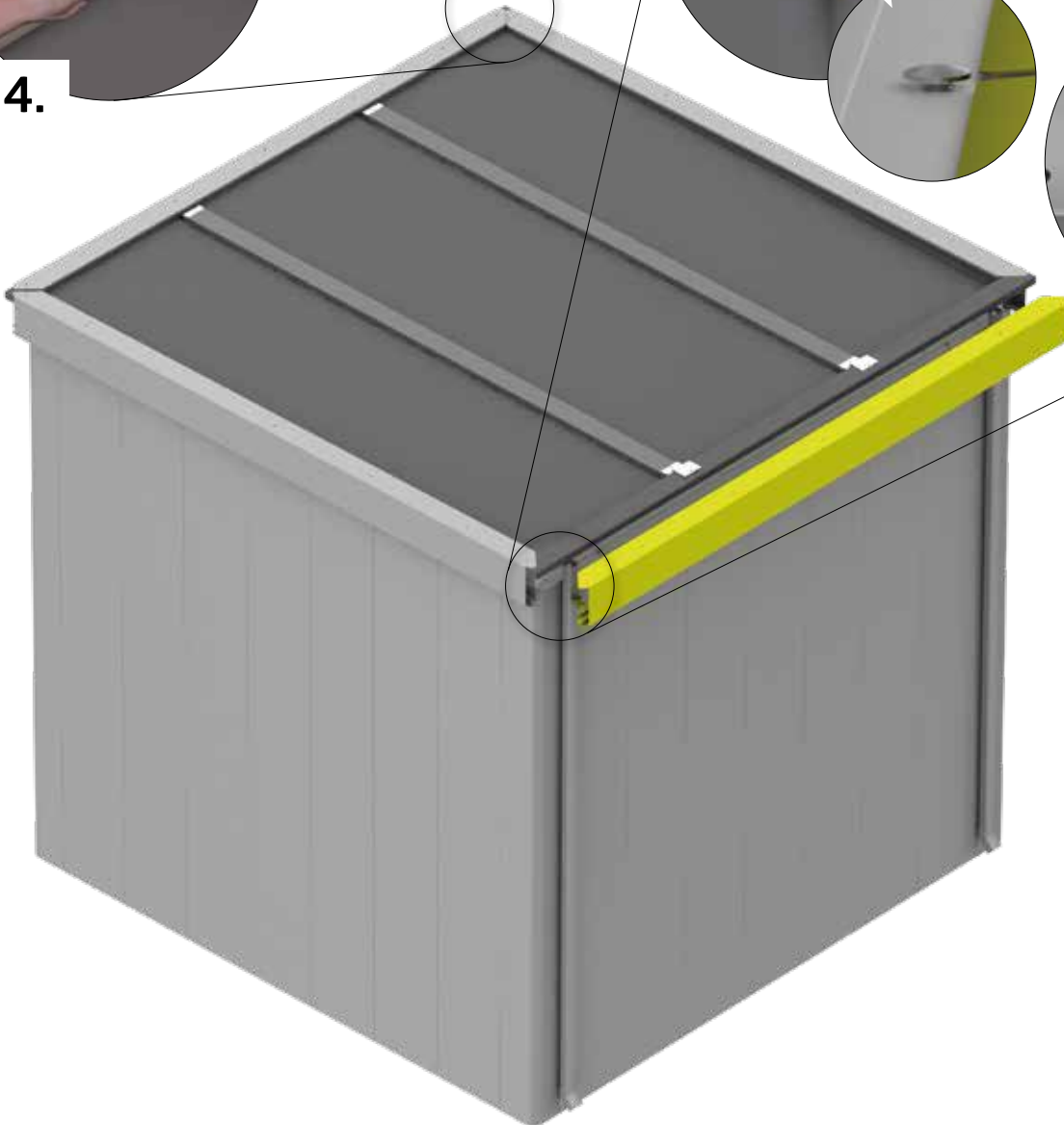
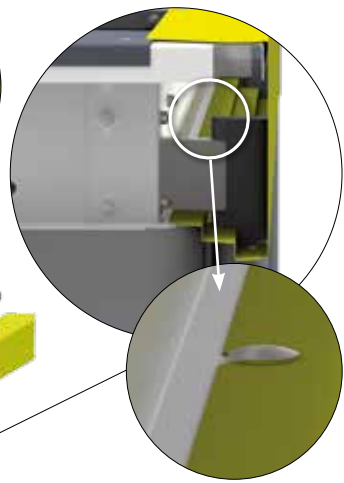
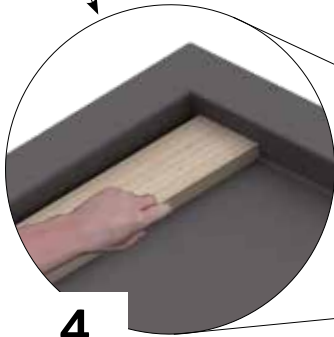



# 36.

4,8 x 19



1A: 12x

2A: 16x

1B: 16x

2B: 20x

## Dichtscheibe verwenden!



- GB Use sealing washer!
- FR Utiliser une rondelle d'étanchéité!
- NL Gebruik de afdichtingsschijf!
- ES ¡Usar la arandela de sellado!
- IT Utilizzare la guarnizione!
- DK Anvend tætningskive!

## Dachstrebe mitverschrauben!

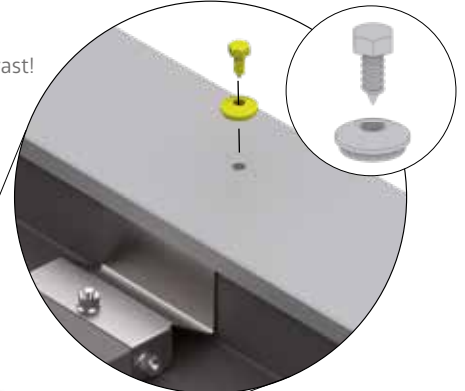
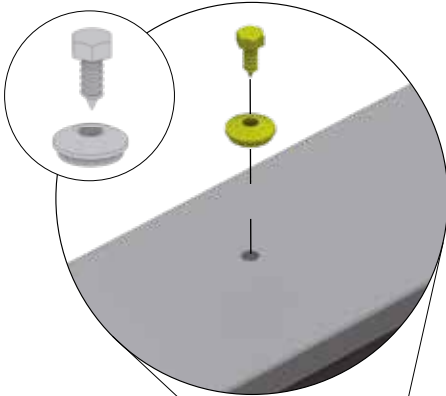
- GB Screw to the roof strut!
- FR Vissez les supports de toit!
- NL Schroef de draagbalk van het dak vast!
- ES ¡Atornille el soporte del techo!
- IT Avvitare il supporto del tetto!
- DK Skru tagstiveren sammen!



# 37.

 <p>(AJ)</p>	<p>5</p> <p>1A: 4x 2A: 4x 1B: 4x 2B: 4x</p>	<p>4,8 x 19</p>  <p>(D1)</p>	<p>7</p> <p>1A: 8x 2A: 8x 1B: 8x 2B: 8x</p>	<p>3,9 x 13</p>  <p>(D1)</p>	<p>7</p> <p>1A: 8x 2A: 8x 1B: 8x 2B: 8x</p>
---	---	--	---	---	---

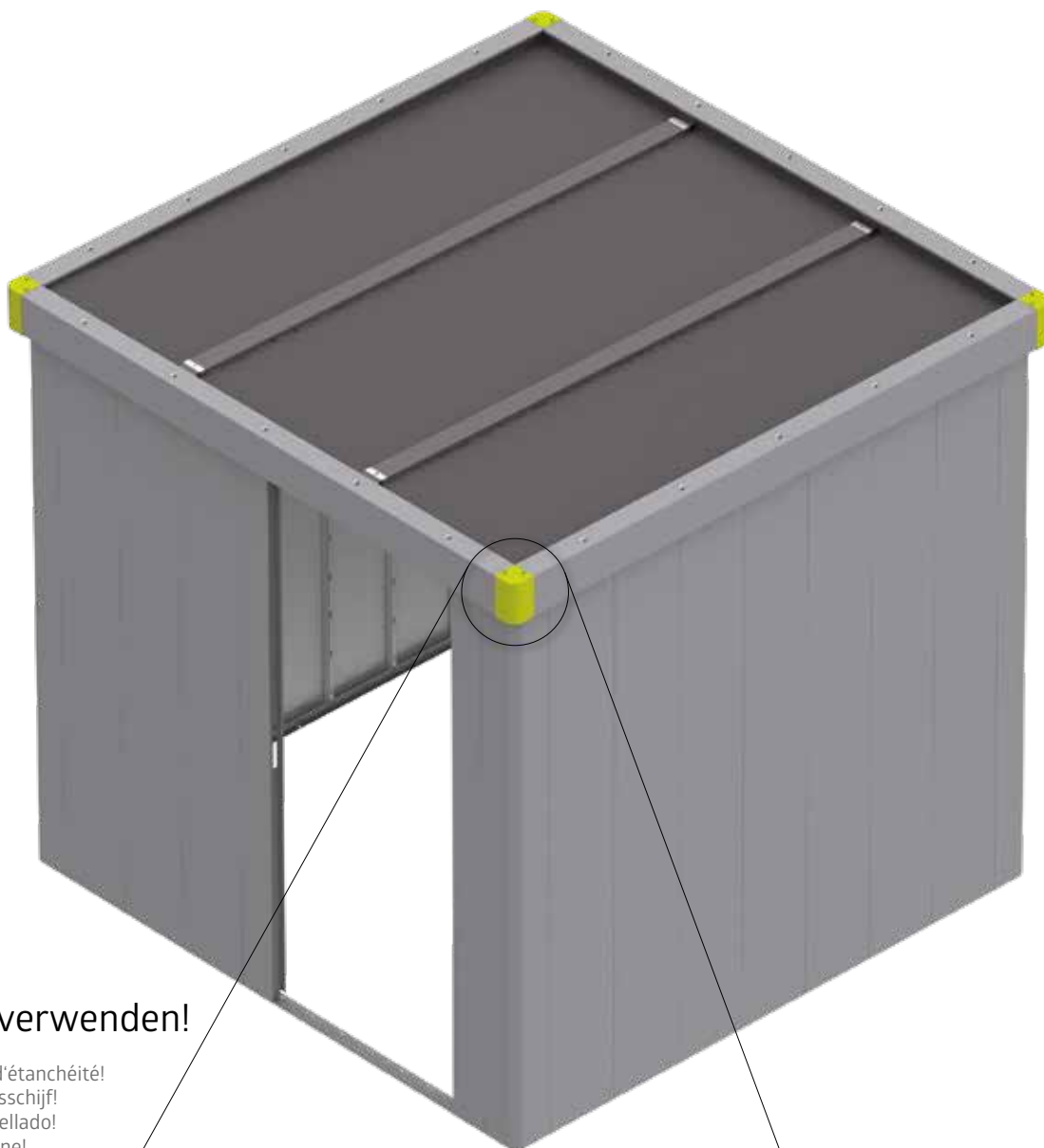

## Dichtscheibe verwenden!

- (GB) Use sealing washer!
- (FR) Utiliser une rondelle d'étanchéité!
- (NL) Gebruik de afdichtingsschijf!
- (ES) !Usar la arandela de sellado!
- (IT) Utilizzare la guarnizione!
- (DK) Anvend tætningskive!

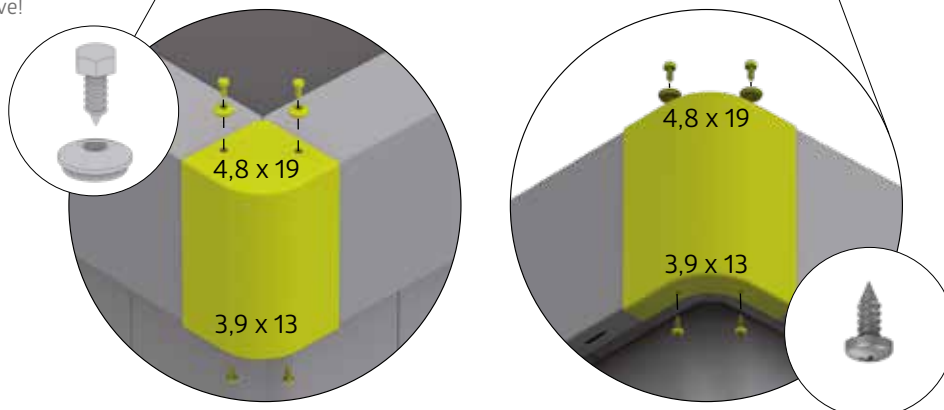

 (RB)	 1A: 2x 2A: 2x 1B: 2x 2B: 2x	4,8 x 13  (D2)	 1A: 6x 2A: 6x 1B: 6x 2B: 6x
---	--	---	--



### Festziehen

- (GB) tighten
- (FR) serrez fort
- (NL) vastdraaien
- (ES) apriete
- (IT) serrare a fondo
- (DK) fastspænding



**EPDM-Dachfolie: Um die Lebensdauer der EPDM-Dachfolie zu verlängern, empfehlen wir die Beschwerung nach dem Aufbau mittels Terrassen-Gehwegplatten oder vergleichbare Beschwerungen (30x30x2/3/4 cm). (Seite 4)**

(GB) In order to prolong the life of the EPDM roofing membrane, we recommend weighting it down after installation using patio slabs (30x30x2/3/4 cm). (Page 4)

(FR) Afin de prolonger la durée de vie de la feuille de toiture EPDM, il est recommandé de la lester après la pose avec des dalles en béton (30x30x2/3/4 cm). (Pages 4)

(NL) Om de levensduur van de EPDM dak folie te verlengen, raden wij aan deze na plaatsing te verzwaren met terras-padtegels (30x30x2/3/4 cm). (Pagina 4)

(ES) Para prolongar la vida útil de la lámina de caucho EPDM, se recomienda reforzarla después de su instalación con baldosas para exteriores o terraza (30x30x2/3/4 cm). (Páginas 4)

(IT) Al fine di prolungare la vita della guaina EPDM, si consiglia di appesantirla dopo l'installazione con mattonelle da patio (30x30x2/3/4 cm). (Pagine 4)

(DK) For at forlænge EPDM-tagfoliens levetid, anbefaler vi at der lægges fliser (30x30x2/3/4 cm). på folien efter opbygningen. (Side 4)



## Bodenrahmen - Doppeltür

Floor frame double door - Cadre de sol Deuxième battant de porte - Bodemframe Tweede deurvleugel - Marco de suelo Segundo battente - Telaio perimetrale Puerta doble - Bundramme Dobbeldør

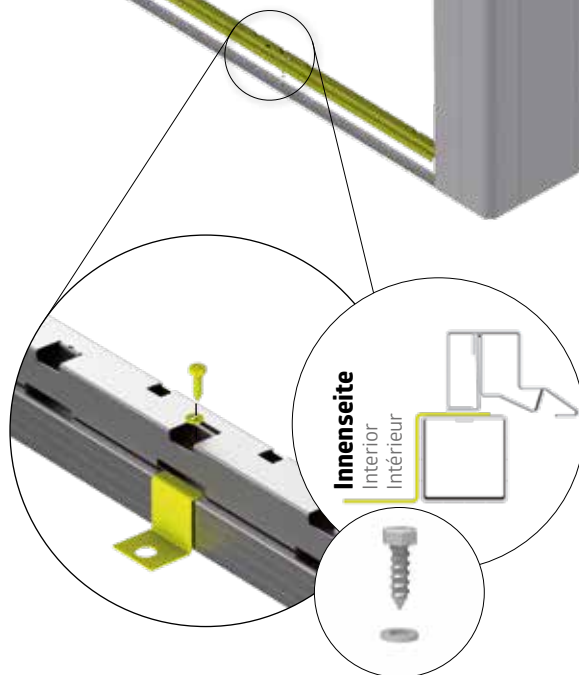
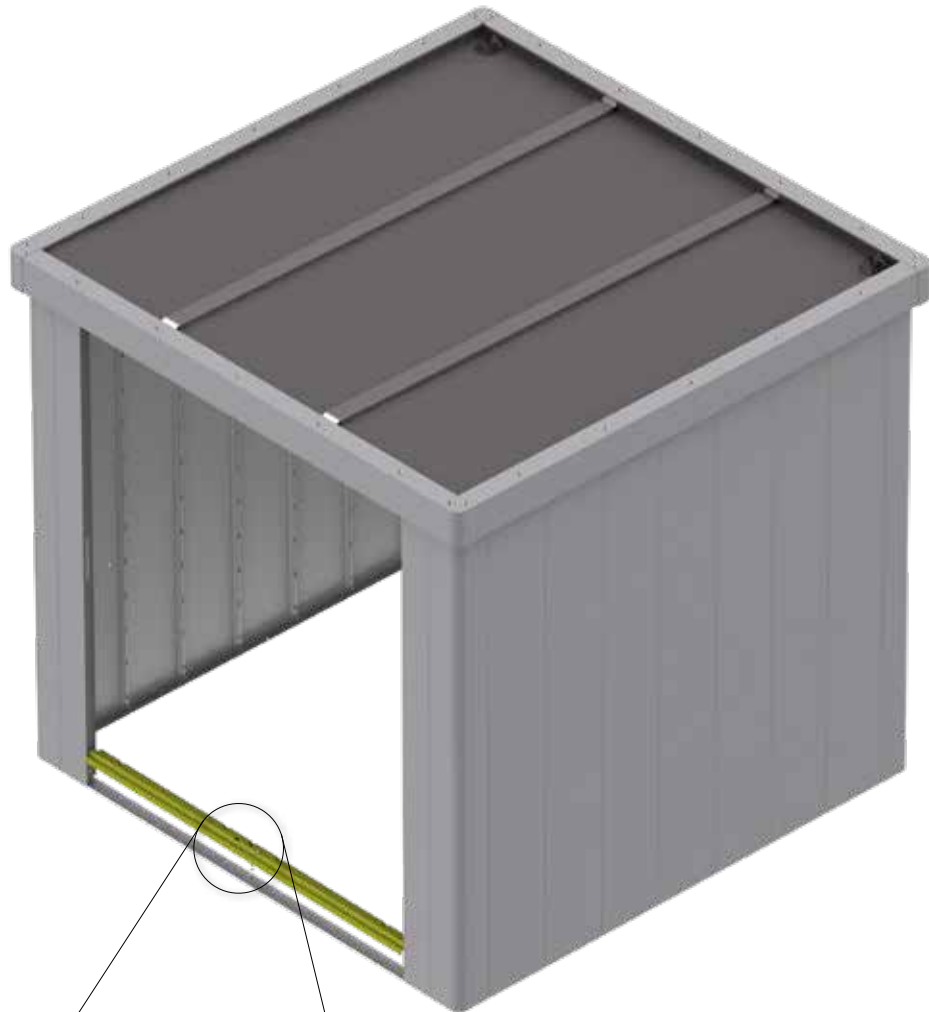

	<p>1B: 1x 2B: 1x</p>	<p>(ZD)</p>	<p>1B: 1x 2B: 1x</p>	<p>6,3 x 22</p> <p>(ZF)</p>	<p>1B: 1x 2B: 1x</p>
--	--------------------------	-------------	--------------------------	-----------------------------	--------------------------



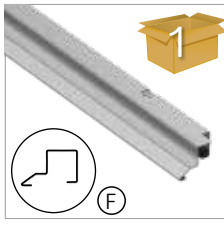

# Bodenrahmen - Standardtür

Floor frame standard door - Cadre de sol porte standard - Bodemframe standaard deur - Marco de suelo puertas estándar - Telaio perimetrale porta standard - Bundramme standarddør

	1A: 1x		1A: 1x		1A: 1x
	2A: 1x		2A: 1x		2A: 1x
	1B: 1x		1B: 1x		1B: 1x
	2B: 1x		2B: 1x		2B: 1x

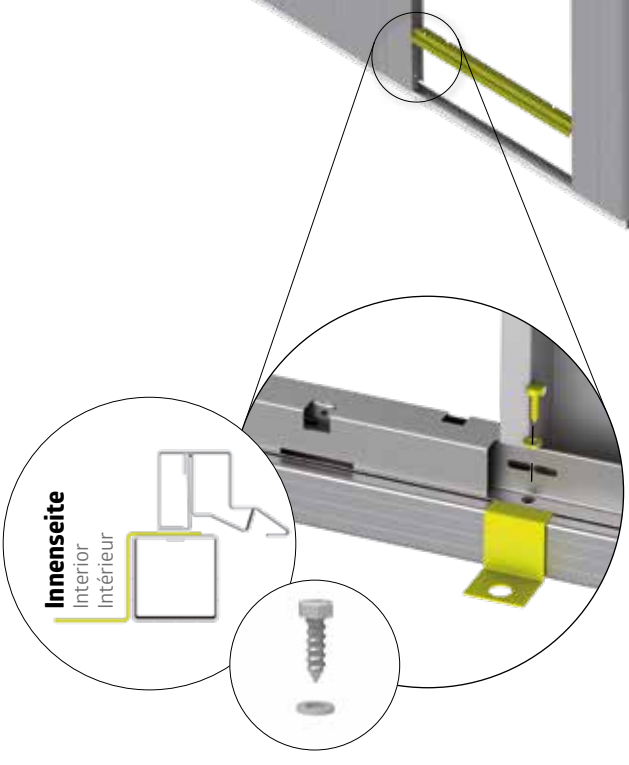
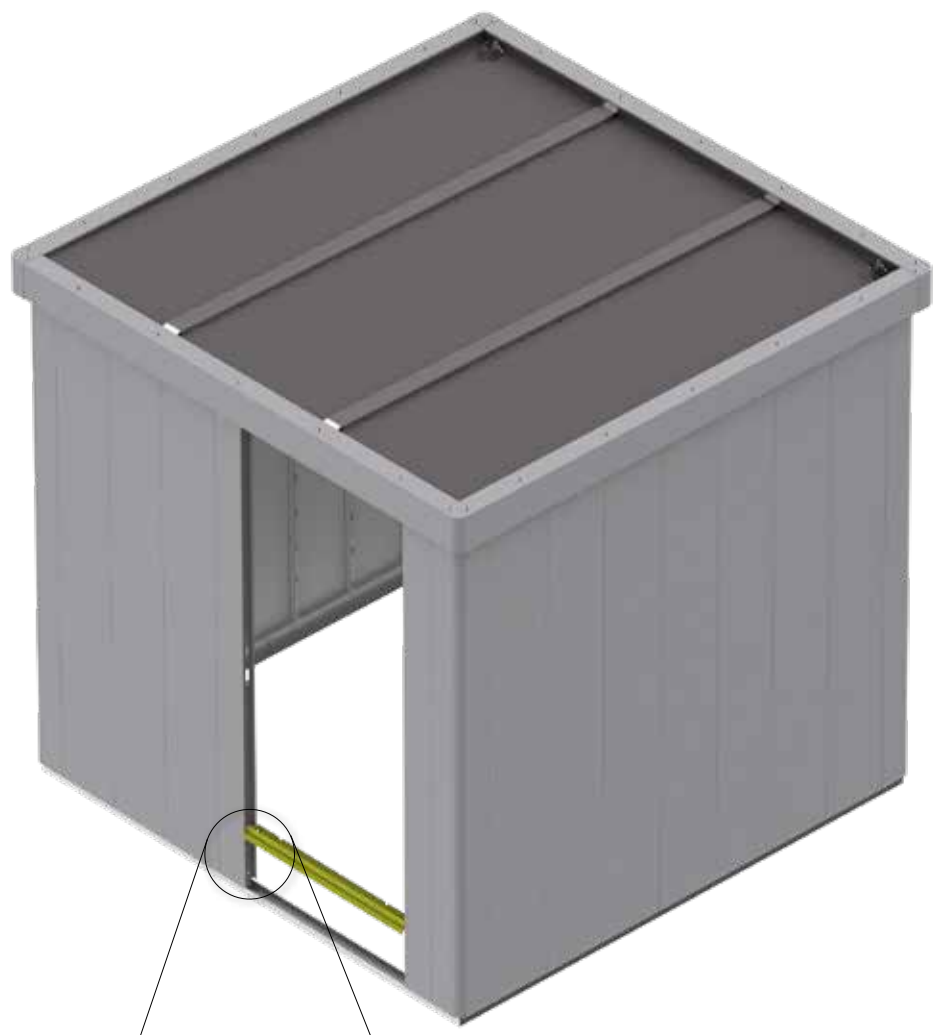



# 39.

	1A: 1X (835 mm)		1A: 2X
	2A: 1X (835 mm)		2A: 2X
	1B: 1X (835 mm)		1B: 2X
	2B: 1X (835 mm)		2B: 2X



<b>OPTION</b> <b>Doppeltür</b> Double door - Deuxième battant de porte - Tweede deurvleugel - Secondo battente - puerta doble - Dobbeldør			1B: 1X (1675 mm)
			2B: 1X (1675 mm)
			1B: 4X
			2B: 4X

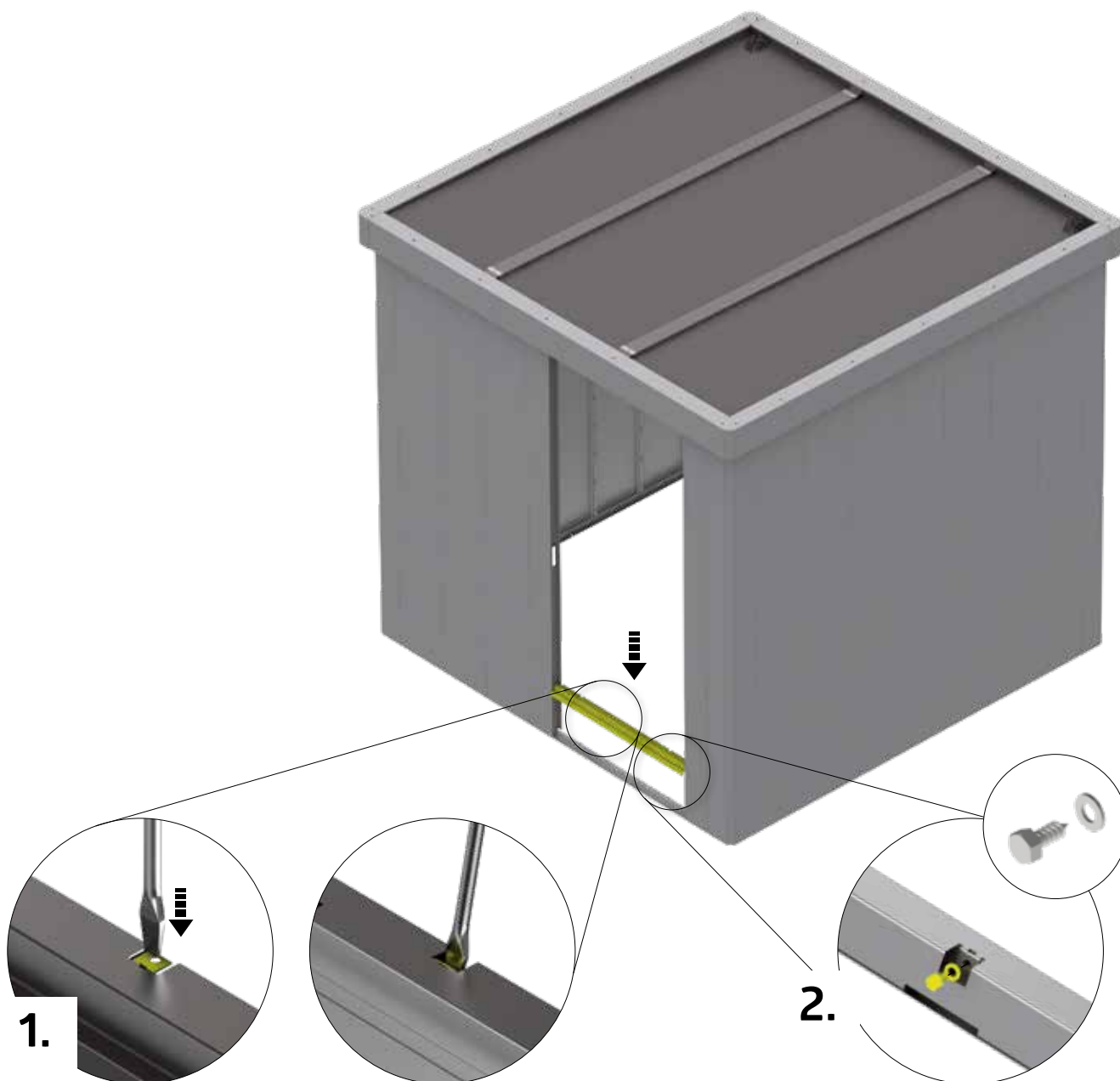

## Bei Verwendung der Bodenschwellen-Rampe überspringen Sie diesen Schritt!

- (GB) When using the threshold access ramp (optional accessory), please skip this step!
- (FR) Si vous utilisez le seuil de porte (accessoire) veuillez passer les étapes!
- (NL) Bij toepassing van de oprijplaat (toebehoren) overslaan stap!
- (ES) Si utiliza rampa de acceso (accesorio opcional) omite este paso en el montaje
- (IT) Se usi la rampa di accesso (accessorio opzionale), puoi saltare questo passaggio
- (DK) Spring dette skridt over, hvis du bruger gulvrampe!



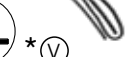
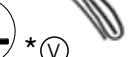





# 40.

	1A: 1x
	2A: 1x
	1B: 1x
	2B: 1x

 \* 

**\* Teil entfällt bei der Doppeltür**



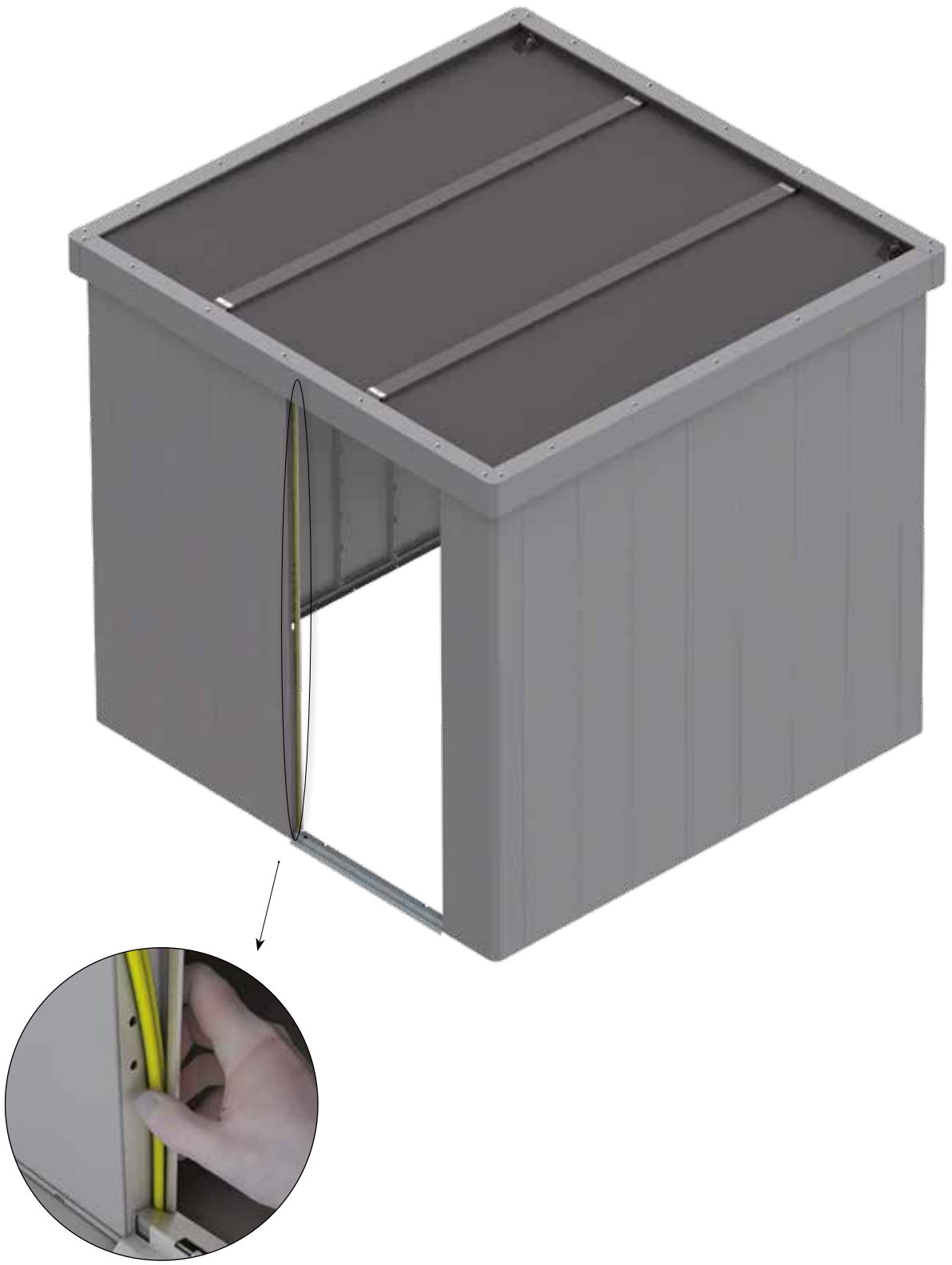

-  Part not required when double doors are fitted
-  La pièce est supprimée pour la double portes.
-  Deel vervalt bij de dubbele deur
-  Pieza no es necesaria en caso de puerta doble
-  Pezzo non può essere utilizzato per la variante porta a due battenti
-  Del ikke nødvendig med dobbeltdør







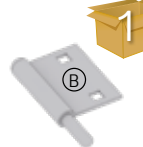

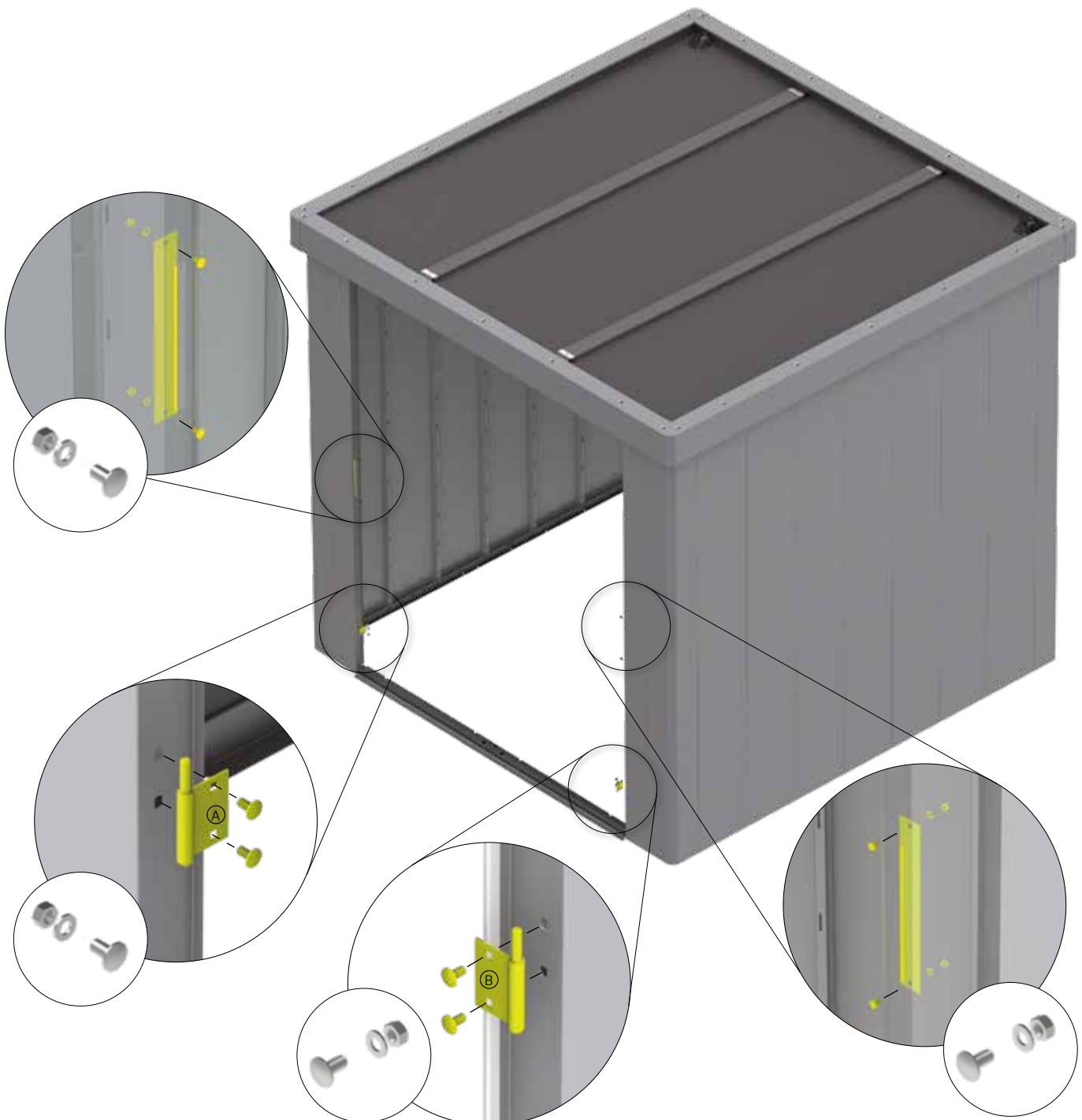

# Doppeltür

Double door - Deuxième battant de porte - Tweede deurvleugel - Secondo battente - Puerta doble - Dobbeldør

 <p>①</p>	<p>1B: 2x 2B: 2x</p>	 <p>Ⓐ</p> <p>ⒹⒹ</p>	<p>1B: 1x 2B: 1x</p>	 <p>Ⓑ</p> <p>ⒹⒹ</p>	<p>1B: 1x 2B: 1x</p>
<p>M5 x 10</p>  <p>ⒹⒹ</p>	<p>1B: 8x 2B: 8x</p>				



# 41.

 <p>①</p>	<p>1A: 1x 2A: 1x 1B: 1x 2B: 1x</p>	 <p>Ⓝ</p>	<p>1A: 1x 2A: 1x 1B: 1x 2B: 1x</p>	 <p>ⓁB</p>	<p>1A: 1x 2A: 1x 1B: 1x 2B: 1x</p>
<p>M5 x 10</p>  <p>ⓁD4</p>	<p>1A: 8x 2A: 8x 1B: 8x 2B: 8x</p>	<p>M5 x 12</p>  <p>ⓁD4</p>	<p>1A: 2x 2A: 2x 1B: 2x 2B: 2x</p>		

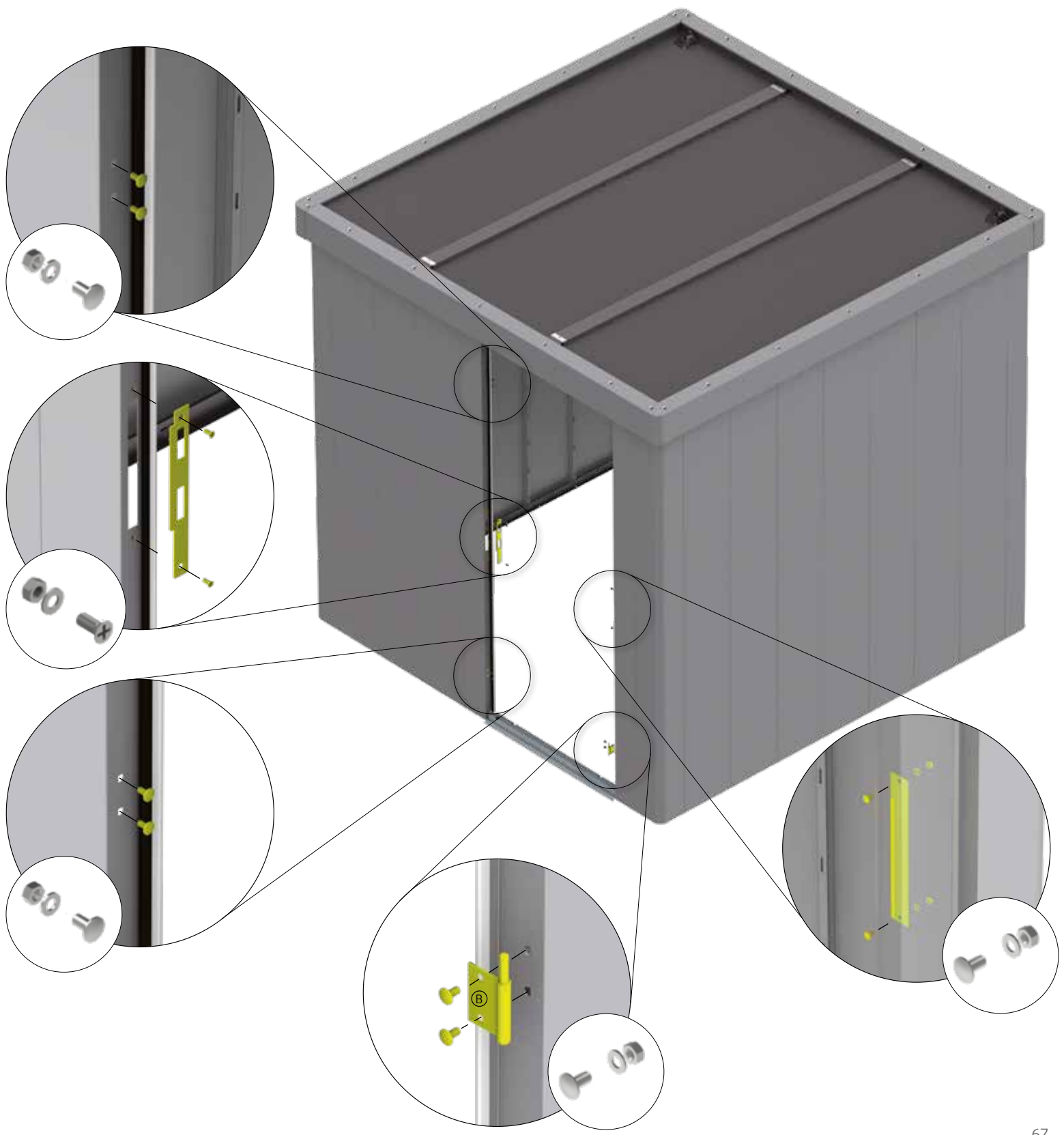



# Doppeltür

Double door - Deuxième battant de porte - Tweede deurvleugel - Secondo battente - Puerta doble - Dobbeldør



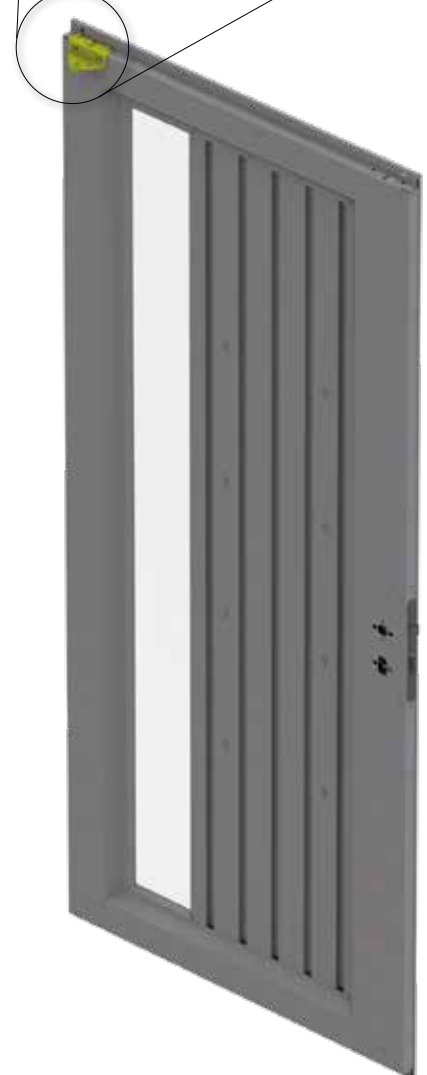



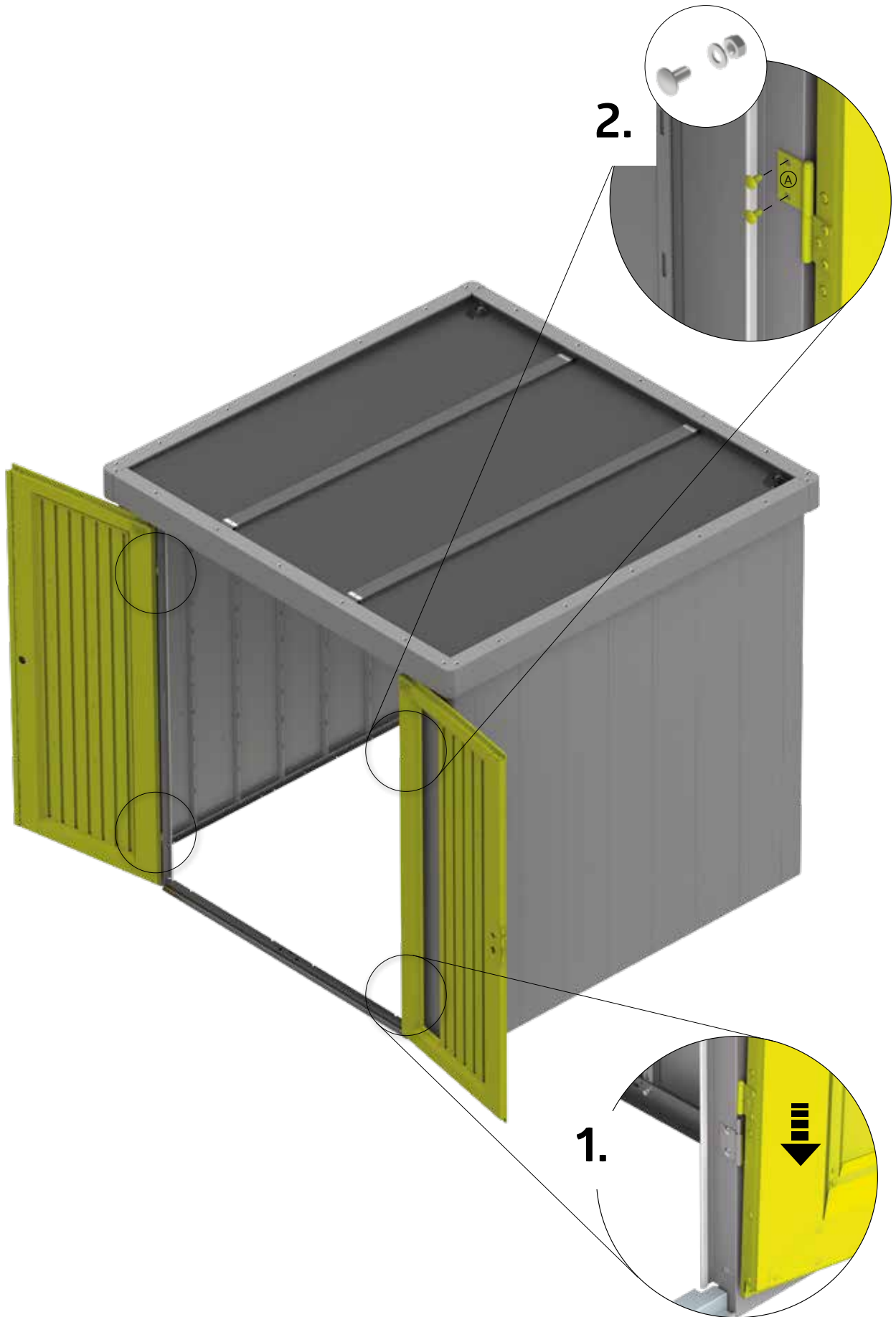

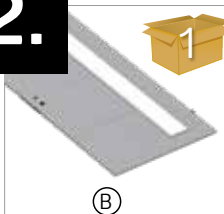

<p>1B: 1x 2B: 1x</p> <p>(B)</p>		<p>1B: 1x 2B: 1x</p> <p>(ZA)</p>		<p>1B: 2x 2B: 2x</p> <p>(J)</p>	
<p>1B: 1x 2B: 1x</p> <p>(D4)</p>		<p>1B: 1x 2B: 1x</p> <p>(D4)</p>		<p>M5 x 10</p> <p>1B: 4x 2B: 4x</p> <p>(D4)</p>	
<p>4,8 x 13</p> <p>1B: 8x 2B: 8x</p> <p>(D4)</p>					

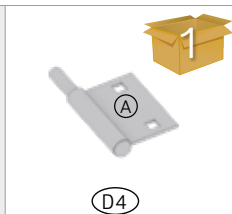







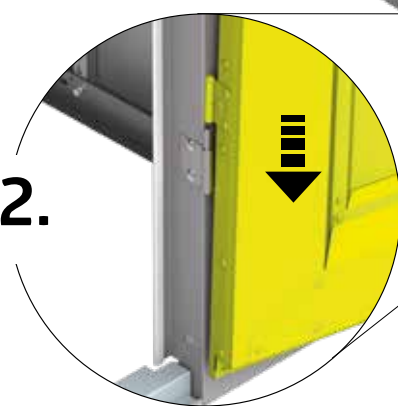
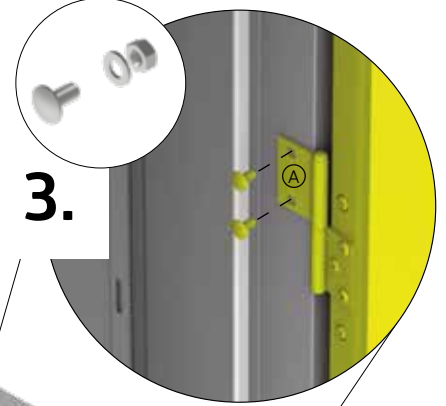
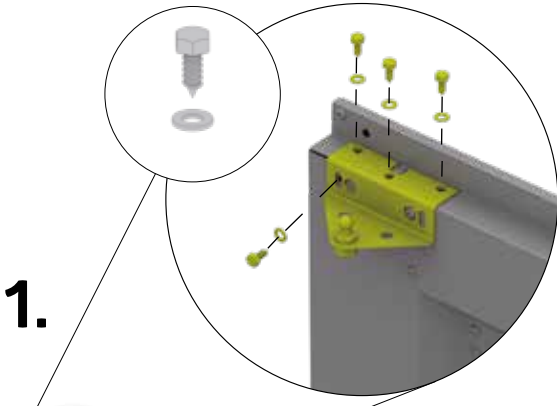

# 42.

 <p>ⓑ</p>	 <p>1A: 1x 2A: 1x 1B: 1x 2B: 1x</p>	 <p>Ⓐ</p>	 <p>1A: 1x 2A: 1x 1B: 1x 2B: 1x</p>	 <p>ⓙ</p>	 <p>1A: 1x 2A: 1x 1B: 1x 2B: 1x</p>
<p>4,8 x 13</p>  <p>ⒹⒶ</p>	 <p>1A: 4x 2A: 4x 1B: 4x 2B: 4x</p>	<p>M5 x 10</p>  <p>ⒹⒶ</p>	 <p>1A: 2x 2A: 2x 1B: 2x 2B: 2x</p>		



# 43.

## Reserveschlüssel für Nachfertigung separat aufbewahren!

  	1A: 1x
	2A: 1x
	1B: 1x
	2B: 1x

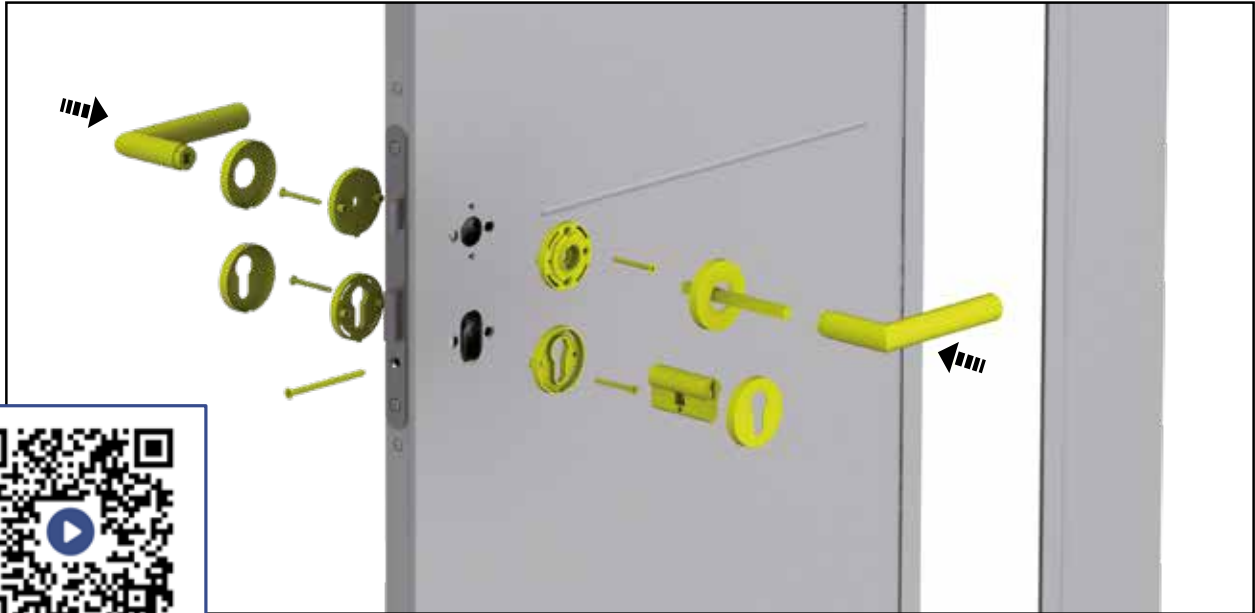

- (GB) Please keep a spare key separately in case you need to make copy
- (FR) Veuillez conserver vos clés de réserve séparément.
- (NL) Reservesleutel a.u.b. apart bewaren. Dit i.v.m. eventuele nabestellingen!
- (ES) Guarde una llave de repuesto separadamente por si tiene que encargar una copia.
- (IT) Conservare la chiave di riserva in luogo sicuro per un' eventuale post-fabbricazione!
- (DK) Gem reservenøglen separat, til hvis du skal lave en kopi!



optionales Zubehör - Accessories - Accessoires - Toebehoor - Accessori - Accesorios - Ekstraudstyr

### Doppeltür

Double door - Deuxième battant de porte - Tweede deurvleugel - Secondo battente - puerta doble - Dobbeltjør

  	1B: 1x	4,8 x 13  	1B: 2x
	2B: 1x		2B: 2x



optionales Zubehör - Accessories - Accessoires - Toebehoor - Accessori - Accesorios - Ekstraudstyr

# 44.



- 1A: 1x
- 2A: 1x
- 1B: 1x
- 2B: 1x

## OPTION Doppeltür

Double door - Deuxième battant de porte -  
Tweede deurvleugel - Secondo battente -  
puerta doble - Dobbeldør



- 1B: 2x
- 2B: 2x

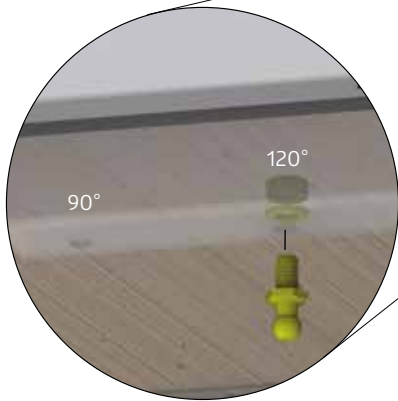
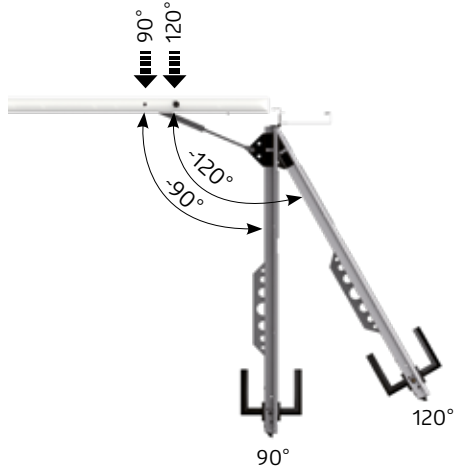

### Ziehen Sie jetzt alle Schraubverbindungen fest an!

Tighten now all nuts and connections securely! - Serrez maintenant les vis à fond! - Draai nu alle schroeven vast! - Ahora puede apretar y fijar todos los tornillos y tuercas - Adesso serrare a fondo tutti i dadi - Fastspænd nu alle bolt-/skrueforbindelser!

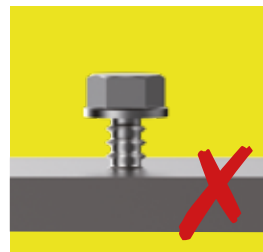
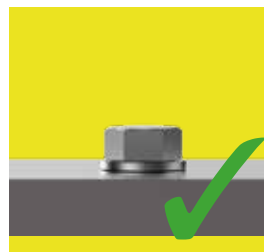

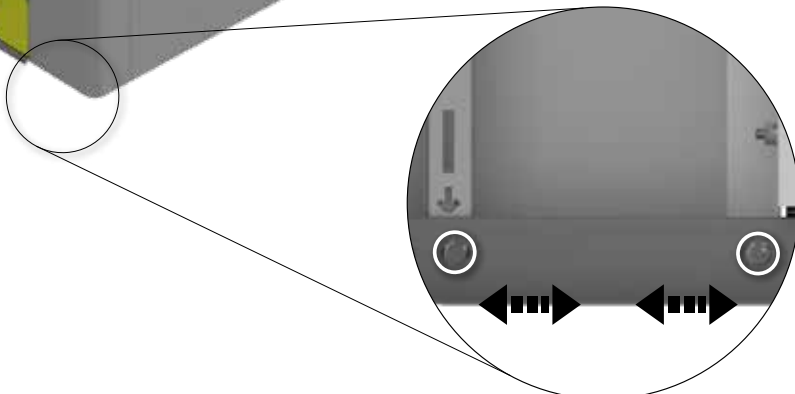
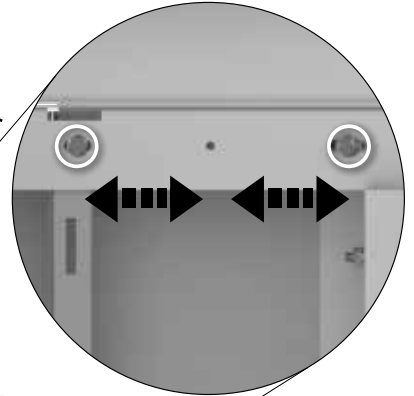
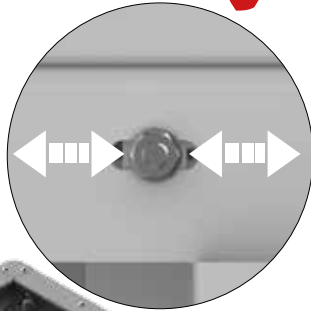
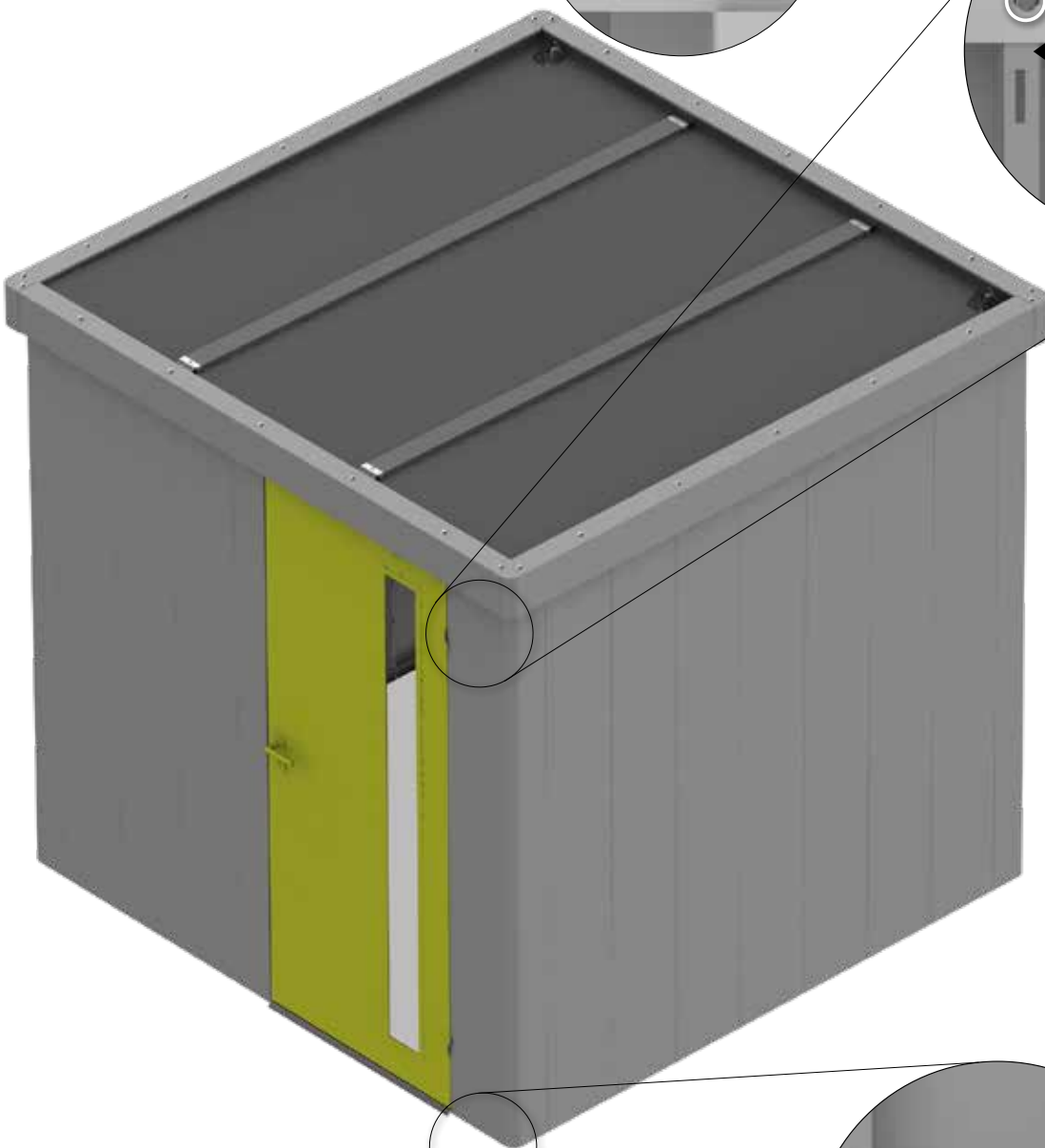
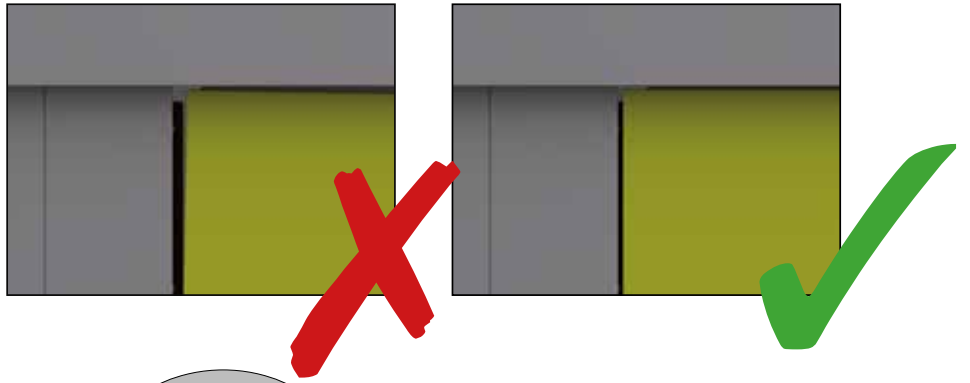

# 45. Türspalt einrichten

- Ⓒ Align door
- Ⓕ Adjuster la porte
- Ⓖ Deuropening inrichten
- Ⓔ Ajuste la puerta
- Ⓗ Predisporre la fessura della porta
- Ⓙ Indstil døren







# 46.

 (H)	 1A: 1x 2A: 1x 1B: 1x 2B: 1x
--	---

<b>OPTION</b> <b>Doppeltür</b> Double door - Deuxième battant de porte - Tweede deurvleugel - Secondo battente - puer- ta doble - Dobbeldør
---

 (H)	 1B: 2x 2B: 2x
--	---





# Bodenrahmen

Floor frame - Cadre de sol - Bodemframe - Marco de suelo - Telaio perimetrale - Bundramme



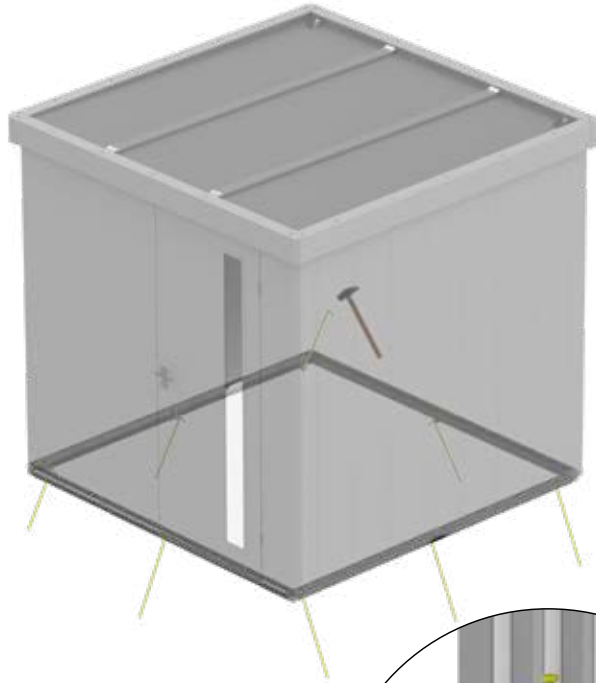
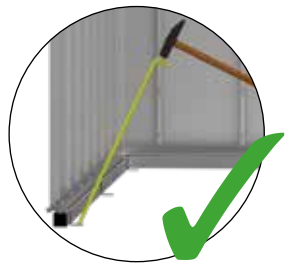
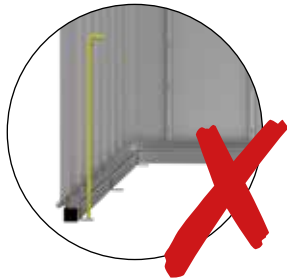
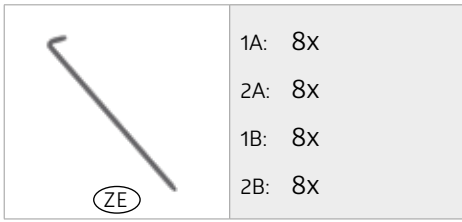

Variante 1 - (Seite 5), Proposal 1 - (page 5), Variant 1 - (page 5)

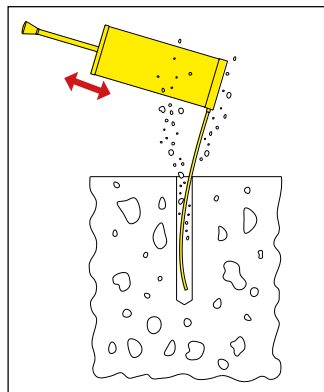
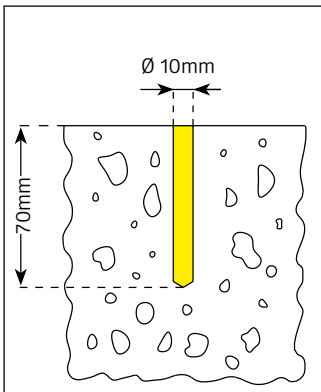
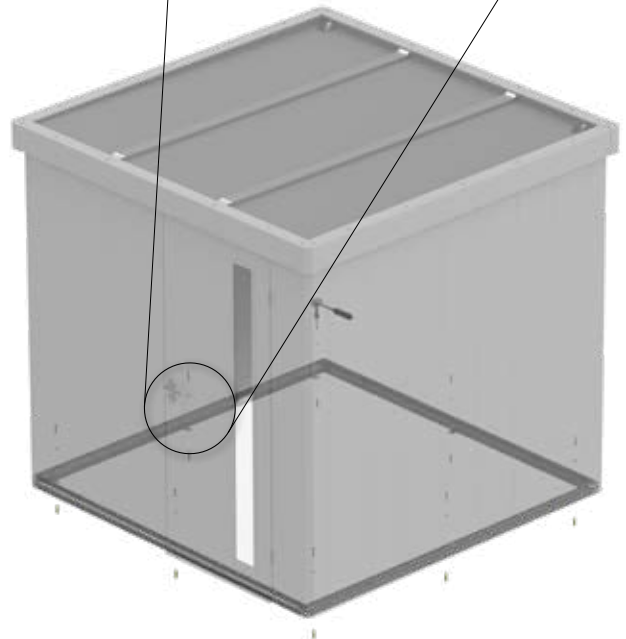
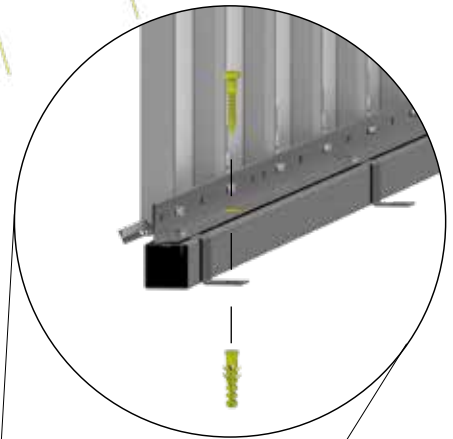
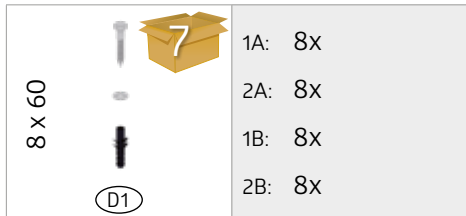



Variante 2 - (Seite 5), Proposal 2 - (page 5), Variant 2 - (page 5)



# 47.

8 x 60		1A: 12x
		2A: 12x
		1B: 12x
		2B: 12x



 7

 D1

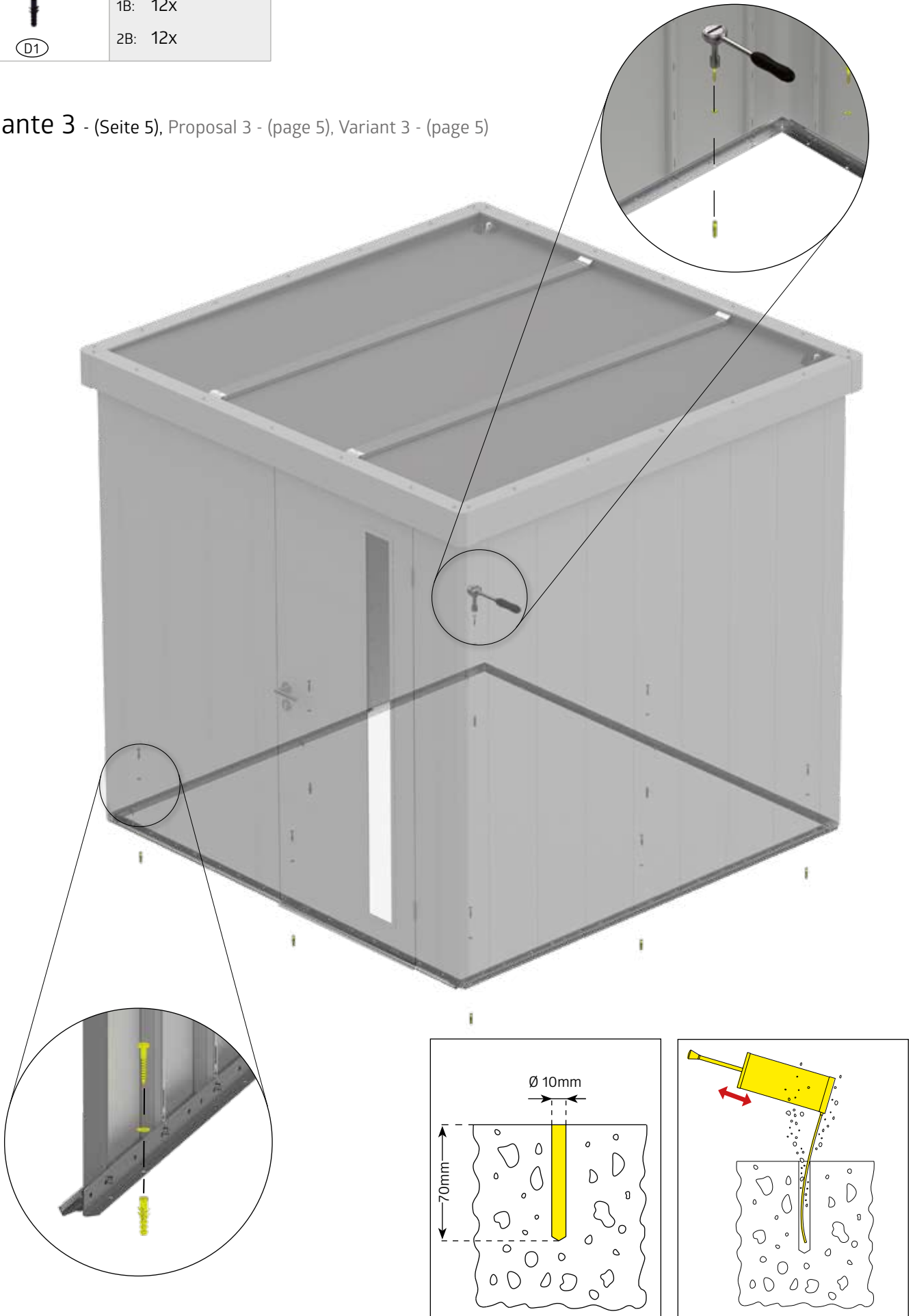
Variante 3 - (Seite 5), Proposal 3 - (page 5), Variant 3 - (page 5)

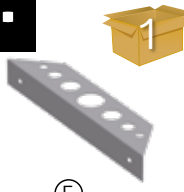

# 48.

 <p>(E)</p>	<p>1A: 2X 2A: 2X 1B: 2X 2B: 2X</p>	<p>M5 x 10</p>  <p>(D4)</p>	<p>1A: 4X 2A: 4X 1B: 4X 2B: 4X</p>	 <p>(D1)</p>	<p>1A: 1X 2A: 1X 1B: 1X 2B: 1X</p>
--	--	--	--	---	--

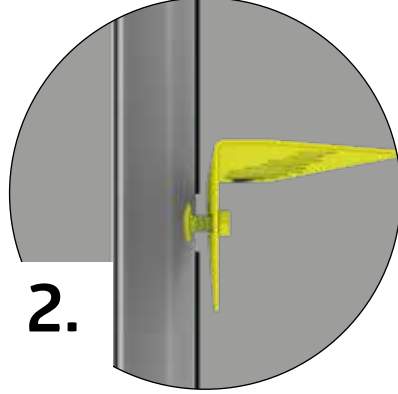
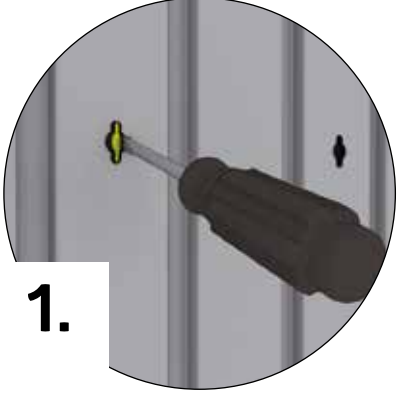

# 49.

	1A: 2x		1A: 4x
	2A: 2x		2A: 4x
	1B: 2x		1B: 4x
	2B: 2x		2B: 4x

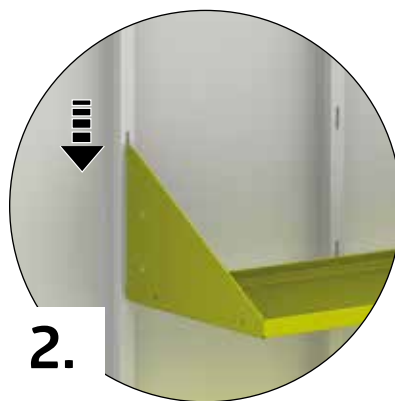
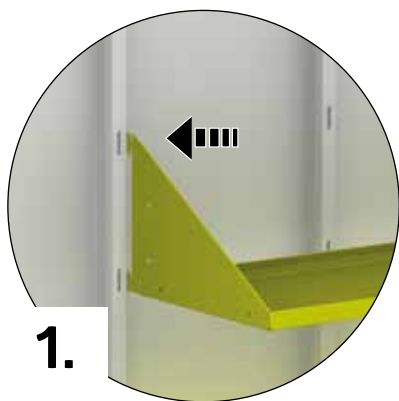

Option 1:



Option 2:

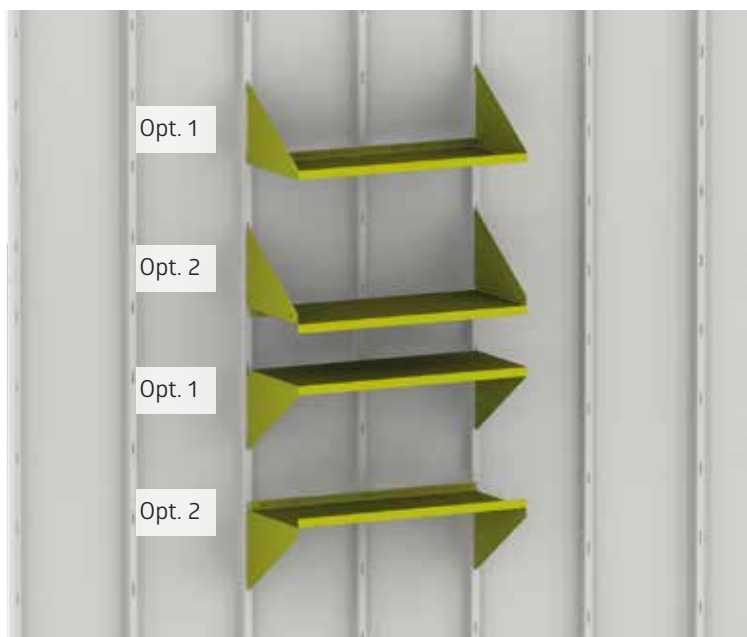
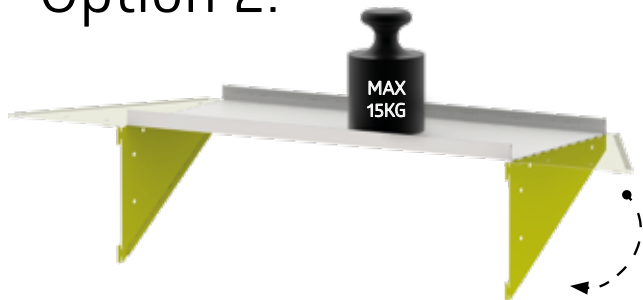



# 50.



(A1)

- 1A: 2X
- 2A: 2X
- 1B: 2X
- 2B: 2X

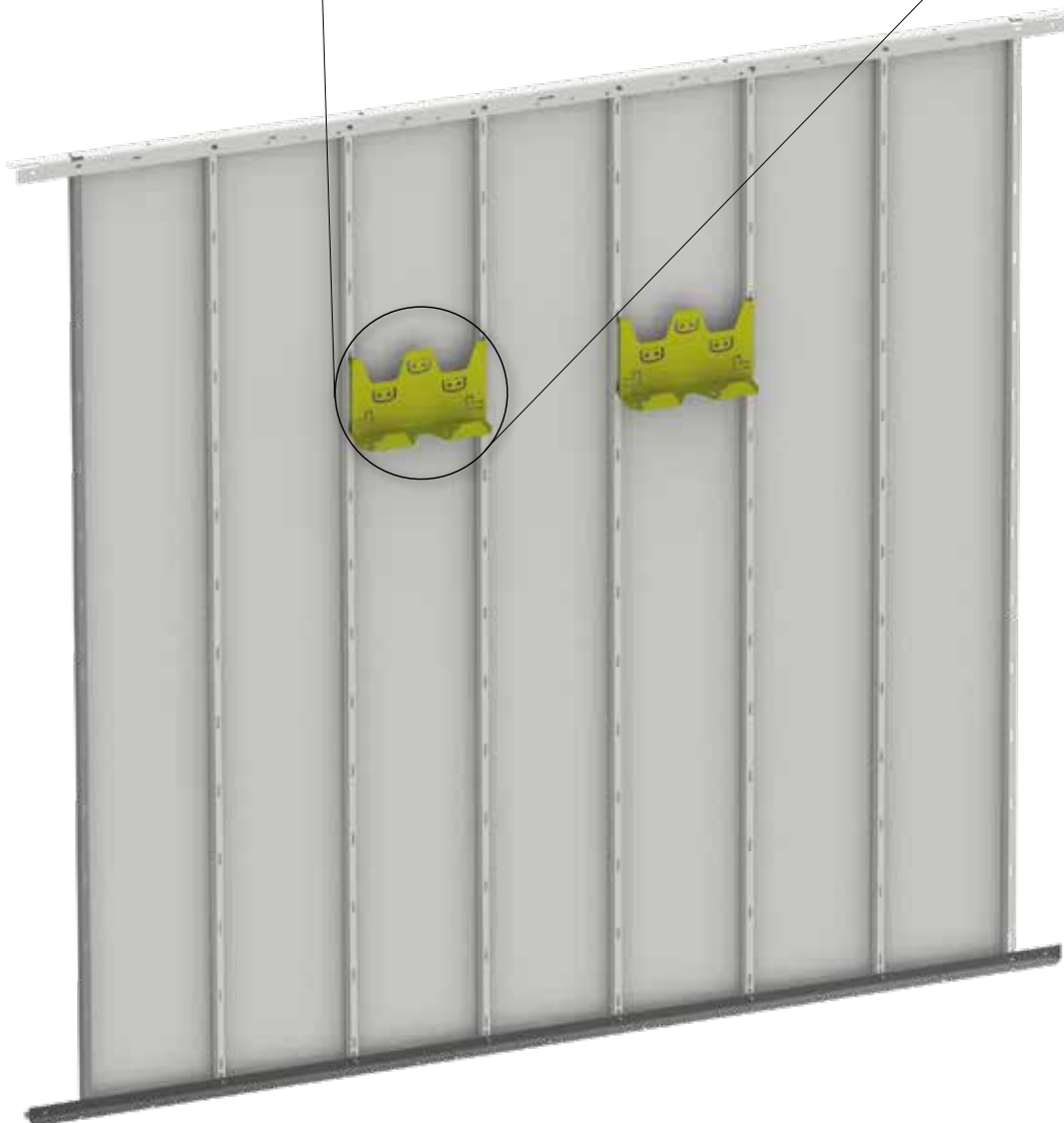
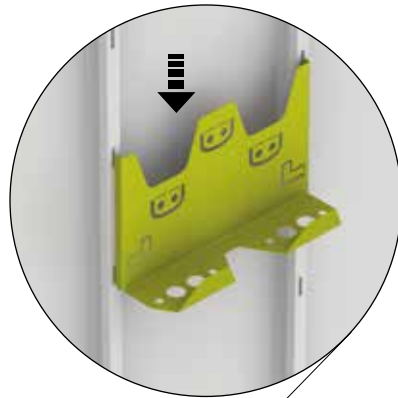
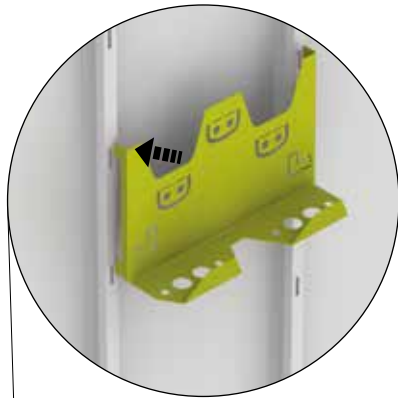

# ABMESSUNGEN GERÄTEHAUS „NEO“

Dimensions garden shed "Neo"

Dimensions de la dépendance Neo

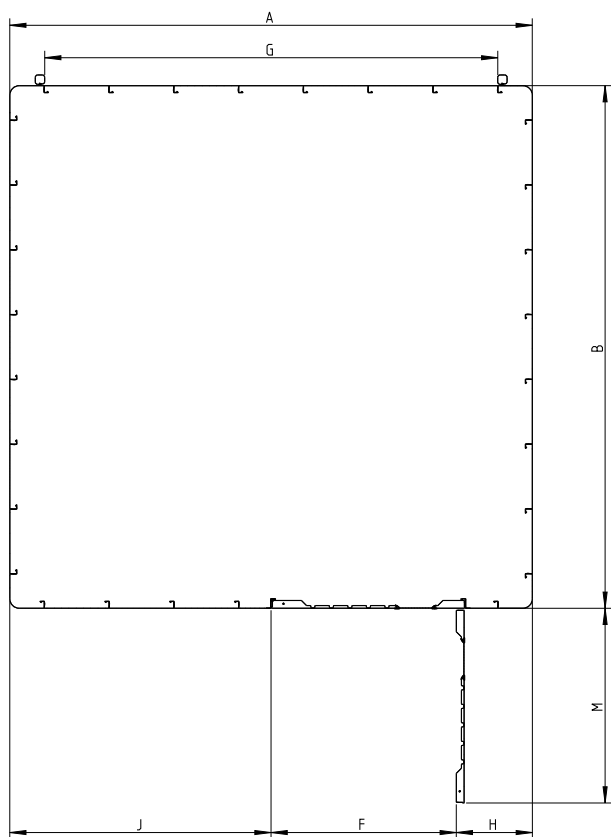
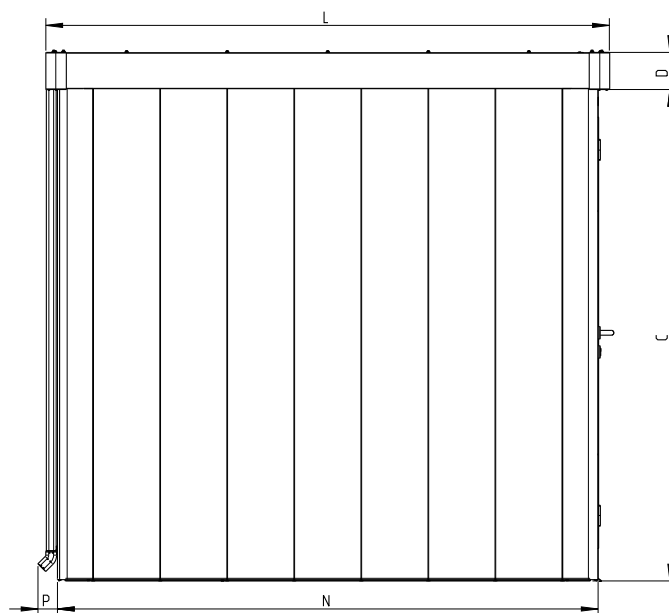
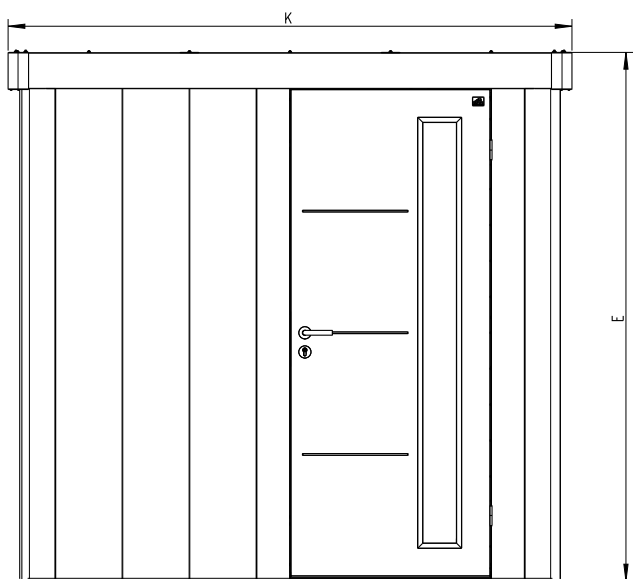

	NEO 1A	NEO 2A	NEO 1B	NEO 2B
A	1700 mm	1700 mm	2260 mm	2260 mm
B	1700 mm	2260 mm	1700 mm	2260 mm
C	2050 mm	2050 mm	2050 mm	2050 mm
D	155 mm	155 mm	155 mm	155 mm
E	2205 mm	2205 mm	2205 mm	2205 mm
F	800 mm	800 mm	800 mm	800 mm
G	1395 mm	1395 mm	1955 mm	1955 mm
H	330 mm	330 mm	330 mm	330 mm
J	570 mm	570 mm	1130 mm	1130 mm
K	1795 mm	1795 mm	2355 mm	2355 mm
L	1795 mm	2355 mm	1795 mm	2355 mm
M	840 mm	840 mm	840 mm	840 mm
N	1700 mm	2260 mm	1700 mm	2260 mm
P	80 mm	80 mm	80 mm	80 mm

# EINREICHPLAN

für die Aufstellung eines Biohort-Gerätehauses Modell „Neo“

# APPROVAL PLAN

for the erection of Biohort garden shed model "Neo"

# DEMANDE

d'autorisation pour la mise en place d'un abri de jardin Biohort Modèle « Neo »

# PLAN VAN GOEDKEURING

voor het bouwen van het Biohort tuinhuis model "Neo"

Adresse Aufstellort / Address at site of erection / Adresse du terrain / Platsingsadres

Grundbuch-Einlagezahl  
Land register-Site No. / Cadastre  
Katastralgemeinde

Grundstücks-Nr.  
Property No. / Parcelle n°  
Kadastraal nummer

Katastralgemeinde  
Council/Borough responsible  
Section/Commune / Eigendomsnummer

## Bauwerber

Building applicant

Demandeur / Opbouwer

Vorname / Christian name / Prénom / Voornaam

Familienname / Surname / Nom / Achternaam

Anschrift / Address / Adresse / Adres

Unterschrift des Bauwerbers / Signature of applicant / Signature du demandeur / Handtekening eigenaar

## Grundstückseigentümer

Property owner

Propriétaire du terrain

Landeigenaar

Vorname / Christian name / Prénom / Voornaam

Familienname / Surname / Nom / Achternaam

Anschrift / Address / Adresse / Adres

Unterschrift des Grundstückseigentümers / Signature of property owner  
Signature du propriétaire / Handtekening eigenaar

## Bodenfläche des Biohort-Gerätehauses:

Floorspace of biohort garden shed:

Surface au sol de l'abri de jardin Biohort :

Oppervlakte van het Biohort tuinhuis:

o Größe 1A / Size 1A / Taille 1A / Grootte 1A = 2,88 m<sup>2</sup>

o Größe 2A / Size 2A / Taille 2A / Grootte 2A = 3,83 m<sup>2</sup>

o Größe 1B / Size 1B / Taille 1B / Grootte 1B = 3,83 m<sup>2</sup>

o Größe 2B / Size 2B / Taille 2B / Grootte 2B = 5,09 m<sup>2</sup>

## Gesamte bebaute Fläche

Total built-up area / Surface totale bâtie / Totaal bebouwde oppervlakte

## Gartenfläche

Garden area / Surface du jardin / Tuin oppervlakte

## Altbau bewilligt

Erection authorised by

Permis de construire du bâtiment existant sur le terrain N°

Opdracht tot opbouw door

vom

Date / En date du / Datum

## Verein

Association / Société / Vereniging

## Lageplan 1 : 500

Siteplan 1 : 500

Plan de masse 1 : 500

Map 1 : 500









**GERÄTEHÄUSER** – Setzen Sie auf Qualität & Langlebigkeit  
**GARDEN SHEDS** – rely on quality & longevity



**GARTENBOXEN** – Outdoorboxen für Garten, Terrasse & Co.  
**OUTDOOR BOXES** – outdoor boxes for garden, patio & more



**FAHRRAD-GARAGEN** – Fahrräder, Roller & Co sicher verstaut  
**BICYCLE STORAGE** – for safe storage of bicycles, scooters & more



**MÜLLTONNEN-BOXEN** – Stylish, praktisch & wartungsfrei  
**DUSTBIN STORAGE** – stylish, practical & maintenance free



**GARTEN-HELFER** – Gartendesign in Bestform  
**GARDENING HELPERS** – garden design at its best

Kontrollnummer:  
 Control-number / Contrôle-Qualité / Controlnummer:



Bei Reklamationen bitte anführen:  
 Kontrollnummer und Artikelnummer des reklamierten Teils.

GB: In case of complaint please indicate the control-number and the number of the item, which is subject of complaint.

F: Pour toutes réclamations: prière de joindre le numéro de contrôle et le numéro d'article de la pièce litigieuse.

NL: Bij reclamaties svp doorgeven: controlnummer en artikelnummer van het desbetreffende onderdeel.



Biohort steht für  
 „LEBEN IM GARTEN“

Biohort stands for  
 „LIFE IN THE GARDEN“

follow us:

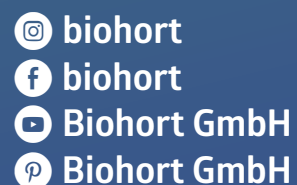

**Biohort GmbH**  
 Pürnstal 43, 4120 Neufelden, Österreich  
 Tel: +43-7282-7788-0  
 E-Mail: office@biohort.at, www.biohort.com